

# Reference Manual for the Model WGR614 Cable/DSL Wireless Router



## **NETGEAR**

**NETGEAR, Inc.**  
4500 Great America Parkway  
Santa Clara, CA 95054 USA

SM-WGR614NA-1  
Version 1.0  
March 2003

© 2003 by NETGEAR, Inc. All rights reserved.

## **Trademarks**

NETGEAR is a trademark of Netgear, Inc.

Microsoft, Windows, and Windows NT are registered trademarks of Microsoft Corporation.

Other brand and product names are registered trademarks or trademarks of their respective holders.

## **Statement of Conditions**

In the interest of improving internal design, operational function, and/or reliability, NETGEAR reserves the right to make changes to the products described in this document without notice.

NETGEAR does not assume any liability that may occur due to the use or application of the product(s) or circuit layout(s) described herein.

## **Federal Communications Commission (FCC) Compliance Notice: Radio Frequency Notice**

This equipment has been tested and found to comply with the limits for a Class B digital device, pursuant to part 15 of the FCC Rules. These limits are designed to provide reasonable protection against harmful interference in a residential installation. This equipment generates, uses, and can radiate radio frequency energy and, if not installed and used in accordance with the instructions, may cause harmful interference to radio communications. However, there is no guarantee that interference will not occur in a particular installation. If this equipment does cause harmful interference to radio or television reception, which can be determined by turning the equipment off and on, the user is encouraged to try to correct the interference by one or more of the following measures:

- Reorient or relocate the receiving antenna.
- Increase the separation between the equipment and receiver.
- Connect the equipment into an outlet on a circuit different from that to which the receiver is connected.
- Consult the dealer or an experienced radio/TV technician for help.

## **EN 55 022 Declaration of Conformance**

This is to certify that the Model WGR614 Cable/DSL Wireless Router is shielded against the generation of radio interference in accordance with the application of Council Directive 89/336/EEC, Article 4a. Conformity is declared by the application of EN 55 022 Class B (CISPR 22).

## **Bestätigung des Herstellers/Importeurs**

Es wird hiermit bestätigt, daß das Model WGR614 Cable/DSL Wireless Router gemäß der im BMPT-AmtsblVfg 243/1991 und Vfg 46/1992 aufgeführten Bestimmungen entstört ist. Das vorschriftsmäßige Betreiben einiger Geräte (z.B. Testsender) kann jedoch gewissen Beschränkungen unterliegen. Lesen Sie dazu bitte die Anmerkungen in der Betriebsanleitung.

Das Bundesamt für Zulassungen in der Telekommunikation wurde davon unterrichtet, daß dieses Gerät auf den Markt gebracht wurde und es ist berechtigt, die Serie auf die Erfüllung der Vorschriften hin zu überprüfen.

## **Certificate of the Manufacturer/Importer**

It is hereby certified that the Model WGR614 Cable/DSL Wireless Router has been suppressed in accordance with the conditions set out in the BMPT-AmtsblVfg 243/1991 and Vfg 46/1992. The operation of some equipment (for example, test transmitters) in accordance with the regulations may, however, be subject to certain restrictions. Please refer to the notes in the operating instructions.

Federal Office for Telecommunications Approvals has been notified of the placing of this equipment on the market and has been granted the right to test the series for compliance with the regulations.

Compliance with the applicable regulations is dependent upon the use of shielded cables. It is the responsibility of the user to procure the appropriate cables.

## **Voluntary Control Council for Interference (VCCI) Statement**

This equipment is in the second category (information equipment to be used in a residential area or an adjacent area thereto) and conforms to the standards set by the Voluntary Control Council for Interference by Data Processing Equipment and Electronic Office Machines aimed at preventing radio interference in such residential areas.

When used near a radio or TV receiver, it may become the cause of radio interference.

Read instructions for correct handling.

## **Customer Support**

Refer to the Support Information Card that shipped with your Model WGR614 Cable/DSL Wireless Router.

## **World Wide Web**

NETGEAR maintains a World Wide Web home page that you can access at the universal resource locator (URL) <http://www.netgear.com>. A direct connection to the Internet and a Web browser such as Internet Explorer or Netscape are required.

This page intentionally left blank.

# Contents

## **Preface**

### **About This Manual**

## **Chapter 1**

### **Introduction**

Key Features of the Router .....	1-1
802.11g Wireless Networking .....	1-2
A Powerful, True Firewall with Content Filtering .....	1-2
Security .....	1-3
Autosensing Ethernet Connections with Auto Uplink™ .....	1-3
Extensive Protocol Support .....	1-3
Easy Installation and Management .....	1-4
Maintenance and Support .....	1-5
Package Contents .....	1-5
The Router's Front Panel .....	1-5
The Router's Rear Panel .....	1-7

## **Chapter 2**

### **Connecting the Router to the Internet**

What You Will Need Before You Begin .....	2-1
Cabling and Computer Hardware Requirements .....	2-1
Computer Network Configuration Requirements .....	2-1
Internet Configuration Requirements .....	2-2
Where Do I Get the Internet Configuration Parameters? .....	2-2
Record Your Internet Connection Information .....	2-3
Connecting the WGR614 to Your LAN .....	2-4
Connecting the Router .....	2-4
PPPoE Smart Wizard-Detected Option .....	2-8
Telstra Bigpond Cable Smart Wizard-Detected Option .....	2-9
Dynamic IP Smart Wizard-Detected Option .....	2-10
Fixed IP Account Smart Wizard-Detected Option .....	2-11

How to Manually Configure Your Internet Connection .....	2-12
<b>Chapter 3</b>	
<b>Wireless Configuration</b>	
Observe Performance, Placement, and Range Guidelines .....	3-1
Implement Appropriate Wireless Security .....	3-2
Understanding Wireless Settings .....	3-3
Common Wireless Settings .....	3-4
Understanding WEP Authentication and Encryption .....	3-5
Authentication Scheme Selection .....	3-5
Encryption Strength Choices .....	3-6
Default Factory Settings .....	3-6
Before You Change the SSID and WEP Settings .....	3-7
How to Set Up and Test Basic Wireless Connectivity .....	3-8
How to Restrict Wireless Access by MAC Address .....	3-9
How to Configure WEP .....	3-11
<b>Chapter 4</b>	
<b>Content Filtering</b>	
Content Filtering Overview .....	4-1
Blocking Access to Internet Sites .....	4-2
Blocking Access to Internet Services .....	4-3
Configuring a User Defined Service .....	4-4
Configuring Services Blocking by IP Address Range .....	4-5
Scheduling When Blocking Will Be Enforced .....	4-5
Viewing Logs of Web Access or Attempted Web Access .....	4-6
Configuring E-Mail Alert and Web Access Log Notifications .....	4-7
<b>Chapter 5</b>	
<b>Maintenance</b>	
Viewing Router Status Information .....	5-1
Viewing a List of Attached Devices .....	5-5
Upgrading the Router Software .....	5-5
Configuration File Management .....	5-6
Restoring and Backing Up the Configuration .....	5-7
Erasing the Configuration .....	5-8
Changing the Administrator Password .....	5-8

## **Chapter 6**

### **Advanced Configuration**

Configuring Port Forwarding to Local Servers .....	6-1
Adding a Port Forwarding Custom Service .....	6-2
Editing or Deleting a Port Forwarding Entry .....	6-3
Local Web and FTP Server Example .....	6-3
Multiple Computers for Half Life, KALI or Quake III Example .....	6-3
Configuring WAN Setup Options .....	6-4
Using a Dynamic DNS Service .....	6-6
Using LAN IP Setup Options .....	6-7
Using the Router as a DHCP server .....	6-9
Using Address Reservation .....	6-9
How to Configure Static Routes .....	6-10
Enabling Remote Management Access .....	6-12
Using Universal Plug and Play (UPnP) .....	6-13

## **Chapter 7**

### **Troubleshooting**

Basic Functioning .....	7-1
Power LED Not On .....	7-1
LEDs Never Turn Off .....	7-2
LAN or WAN Port LEDs Not On .....	7-2
Troubleshooting the Web Configuration Interface .....	7-3
Troubleshooting the ISP Connection .....	7-4
Troubleshooting a TCP/IP Network Using a Ping Utility .....	7-5
Testing the LAN Path to Your Router .....	7-5
Testing the Path from Your PC to a Remote Device .....	7-6
Restoring the Default Configuration and Password .....	7-7
Problems with Date and Time .....	7-7

## **Appendix A**

### **Technical Specifications**

## **Appendix B**

### **Network, Routing, Firewall, and Basics**

Related Publications .....	B-1
Basic Router Concepts .....	B-1
What is a Router? .....	B-2
Routing Information Protocol .....	B-2

IP Addresses and the Internet .....	B-2
Netmask .....	B-4
Subnet Addressing .....	B-5
Private IP Addresses .....	B-7
Single IP Address Operation Using NAT .....	B-8
MAC Addresses and Address Resolution Protocol .....	B-9
Related Documents .....	B-9
Domain Name Server .....	B-10
IP Configuration by DHCP .....	B-10
Internet Security and Firewalls .....	B-10
What is a Firewall? .....	B-11
Stateful Packet Inspection .....	B-11
Denial of Service Attack .....	B-11
Ethernet Cabling .....	B-12
Uplink Switches, Crossover Cables, and MDI/MDIX Switching .....	B-12
Cable Quality .....	B-13

## **Appendix C**

### **Preparing Your Network**

Preparing Your Computers for TCP/IP Networking .....	C-1
Configuring Windows 95, 98, and Me for TCP/IP Networking .....	C-2
Install or Verify Windows Networking Components .....	C-2
Enabling DHCP to Automatically Configure TCP/IP Settings .....	C-4
Selecting Windows' Internet Access Method .....	C-6
Verifying TCP/IP Properties .....	C-6
Configuring Windows NT4, 2000 or XP for IP Networking .....	C-7
Install or Verify Windows Networking Components .....	C-7
DHCP Configuration of TCP/IP in Windows XP, 2000, or NT4 .....	C-8
DHCP Configuration of TCP/IP in Windows XP .....	C-8
DHCP Configuration of TCP/IP in Windows 2000 .....	C-10
DHCP Configuration of TCP/IP in Windows NT4 .....	C-13
Verifying TCP/IP Properties for Windows XP, 2000, and NT4 .....	C-15
Configuring the Macintosh for TCP/IP Networking .....	C-16
MacOS 8.6 or 9.x .....	C-16
MacOS X .....	C-16
Verifying TCP/IP Properties for Macintosh Computers .....	C-17



Verifying the Readiness of Your Internet Account .....	C-18
Are Login Protocols Used? .....	C-18
What Is Your Configuration Information? .....	C-18
Obtaining ISP Configuration Information for Windows Computers .....	C-19
Obtaining ISP Configuration Information for Macintosh Computers .....	C-20
Restarting the Network .....	C-21

## **Appendix D**

### **Wireless Networking Basics**

Wireless Networking Overview .....	D-1
Infrastructure Mode .....	D-2
Ad Hoc Mode (Peer-to-Peer Workgroup) .....	D-2
Network Name: Extended Service Set Identification (ESSID) .....	D-2
Authentication and WEP .....	D-3
802.11 Authentication .....	D-3
Open System Authentication .....	D-4
Shared Key Authentication .....	D-4
Overview of WEP Parameters .....	D-5
Key Size .....	D-6
WEP Configuration Options .....	D-7
Wireless Channels .....	D-7

### **Glossary**

### **Index**



# Preface

## About This Manual

Congratulations on your purchase of the NETGEAR® Model WGR614 Cable/DSL Wireless Router. The WGR614 router provides connection for multiple personal computers (PCs) to the Internet through an external broadband access device (such as a cable modem or DSL modem) that is normally intended for use by a single PC.

### Audience

---

This reference manual assumes that the reader has basic to intermediate computer and Internet skills. However, basic computer network, Internet, firewall, and VPN technologies tutorial information is provided in the Appendices and on the Netgear website.

### Typographical Conventions

---

This guide uses the following typographical conventions:

<i>italics</i>	Emphasis.
<b>bold times roman</b>	User input.
<u>Internet Protocol</u> (IP)	First time an abbreviated term is used.
<code>courier font</code>	Screen text, user-typed command-line entries.
[Enter]	Named keys in text are shown enclosed in square brackets. The notation [Enter] is used for the Enter key and the Return key.
[Ctrl]+C	Two or more keys that must be pressed simultaneously are shown in text linked with a plus (+) sign.
SMALL CAPS	DOS file and directory names.

## **Special Message Formats**

---

This guide uses the following formats to highlight special messages:

	<b>Note:</b> This format is used to highlight information of importance or special interest.
---	--

# Chapter 1

## Introduction

This chapter describes the features of the NETGEAR Model WGR614 Cable/DSL Wireless Router.

### Key Features of the Router

---

The Model WGR614 Cable/DSL Wireless Router with 4-port switch connects your local area network (LAN) to the Internet through an external access device such as a cable modem or DSL modem.

The WGR614 router provides you with multiple Web content filtering options, plus browsing activity reporting and instant alerts -- both via e-mail. Parents and network administrators can establish restricted access policies based on time-of-day, Website addresses and address keywords, and share high-speed cable/DSL Internet access for up to 253 personal computers. In addition to the Network Address Translation (NAT) feature, the built-in firewall protects you from hackers.

With minimum setup, you can install and use the router within minutes.

The WGR614 router provides the following features:

- 802.11g wireless networking, with the ability to operate in 802.11g-only or 802.11b+g modes.
- Easy, web-based setup for installation and management.
- Content Filtering and Site Blocking Security.
- Built in 4-port 10/100 Mbps Switch.
- Ethernet connection to a wide area network (WAN) device, such as a cable modem or DSL modem.
- Extensive Protocol Support.
- Login capability.
- Front panel LEDs for easy monitoring of status and activity.

- Flash memory for firmware upgrade.

## 802.11g Wireless Networking

The WGR614 router includes an 802.11g wireless access point, providing continuous, high-speed 54 Mbps access between your wireless and Ethernet devices. The access point provides:

- 802.11g wireless networking at up to 54 Mbps.
- 802.11g wireless networking, with the ability to operate in 802.11g-only or 802.11b+g modes, providing backwards compatibility with 802.11b devices or dedicating the wireless network to the higher bandwidth 802.11g 54Mbps devices.
- 64-bit and 128-bit WEP encryption security.
- WEP keys can be generated manually or by passphrase.
- Wireless access can be restricted by MAC address.
- Wireless network name broadcast can be turned off so that only devices that have the network name (SSID) can connect.

## A Powerful, True Firewall with Content Filtering

Unlike simple Internet sharing NAT routers, the WGR614 is a true firewall, using stateful packet inspection to defend against hacker attacks. Its firewall features include:

- Denial of Service (DoS) protection.  
Automatically detects and thwarts DoS attacks such as Ping of Death, SYN Flood, LAND Attack, and IP Spoofing.
- Blocks unwanted traffic from the Internet to your LAN.
- Blocks access from your LAN to Internet locations or services that you specify as off-limits.
- Logs security incidents.

The WGR614 will log security events such as blocked incoming traffic, port scans, attacks, and administrator logins. You can configure the router to email the log to you at specified intervals. You can also configure the router to send immediate alert messages to your email address or email pager whenever a significant event occurs.

- With its content filtering feature, the WGR614 prevents objectionable content from reaching your PCs. The router allows you to control access to Internet content by screening for keywords within Web addresses. You can configure the router to log and report attempts to access objectionable Internet sites.

## Security

The WGR614 router is equipped with several features designed to maintain security, as described in this section.

- **PCs Hidden by NAT**  
NAT opens a temporary path to the Internet for requests originating from the local network. Requests originating from outside the LAN are discarded, preventing users outside the LAN from finding and directly accessing the PCs on the LAN.
- **Port Forwarding with NAT**  
Although NAT prevents Internet locations from directly accessing the PCs on the LAN, the router allows you to direct incoming traffic to specific PCs based on the service port number of the incoming request, or to one designated “DMZ” host computer. You can specify forwarding of single ports or ranges of ports.

## Autosensing Ethernet Connections with Auto Uplink™

With its internal 8-port 10/100 switch, the WGR614 can connect to either a 10 Mbps standard Ethernet network or a 100 Mbps Fast Ethernet network. Both the LAN and WAN interfaces are autosensing and capable of full-duplex or half-duplex operation.

The router incorporates Auto Uplink™ technology. Each Ethernet port will automatically sense whether the Ethernet cable plugged into the port should have a ‘normal’ connection such as to a PC or an ‘uplink’ connection such as to a switch or hub. That port will then configure itself to the correct configuration. This feature also eliminates the need to worry about crossover cables, as Auto Uplink will accommodate either type of cable to make the right connection.

## Extensive Protocol Support

The WGR614 router supports the Transmission Control Protocol/Internet Protocol (TCP/IP) and Routing Information Protocol (RIP). For further information about TCP/IP, refer to [Appendix B, “Network, Routing, Firewall, and Basics.”](#)

- **IP Address Sharing by NAT**  
The WGR614 router allows several networked PCs to share an Internet account using only a single IP address, which may be statically or dynamically assigned by your Internet service provider (ISP). This technique, known as NAT, allows the use of an inexpensive single-user ISP account.
- **Automatic Configuration of Attached PCs by DHCP**  
The WGR614 router dynamically assigns network configuration information, including IP, gateway, and domain name server (DNS) addresses, to attached PCs on the LAN using the Dynamic Host Configuration Protocol (DHCP). This feature greatly simplifies configuration of PCs on your local network.
- **DNS Proxy**  
When DHCP is enabled and no DNS addresses are specified, the router provides its own address as a DNS server to the attached PCs. The router obtains actual DNS addresses from the ISP during connection setup and forwards DNS requests from the LAN.
- **PPP over Ethernet (PPPoE)**  
PPPoE is a protocol for connecting remote hosts to the Internet over a DSL connection by simulating a dial-up connection. This feature eliminates the need to run a login program such as Entersys or WinPOET on your PC.

## Easy Installation and Management

You can install, configure, and operate the Model WGR614 Cable/DSL Wireless Router within minutes after connecting it to the network. The following features simplify installation and management tasks:

- **Browser-based management**  
Browser-based configuration allows you to easily configure your router from almost any type of personal computer, such as Windows, Macintosh, or Linux. A user-friendly Setup Wizard is provided and online help documentation is built into the browser-based Web Management Interface.
- **Smart Wizard™**  
The WGR614 router Smart Wizard automatically senses the type of Internet connection, asking you only for the information required for your type of ISP account.
- **Visual monitoring**  
The WGR614 router's front panel LEDs provide an easy way to monitor its status and activity.



## Maintenance and Support

NETGEAR offers the following features to help you maximize your use of the WGR614 router:

- Flash memory for firmware upgrade
- Free technical support seven days a week, twenty-four hours a day

## Package Contents

---

The product package should contain the following items:

- Model WGR614 Cable/DSL Wireless Router.
- AC power adapter.
- Category 5 (CAT5) Ethernet cable.
- *Model WGR614 Resource CD*, including:
  - This guide.
  - Application Notes and other helpful information.
- *WGR614 Cable/DSL Wireless Router Installation Guide*.
- Registration and Warranty Card.
- Support Information Card.

If any of the parts are incorrect, missing, or damaged, contact your NETGEAR dealer. Keep the carton, including the original packing materials, in case you need to return the router for repair.

## The Router's Front Panel





The front panel of the WGR614 router contains the status LEDs described below.



**Figure 1-1: WGR614 Front Panel**

You can use some of the LEDs to verify connections. Viewed from left to right, [Table 2](#) describes the LEDs on the front panel of the router. These LEDs are green when lit.

**Table 2. LED Descriptions**

Label	Activity	Description
 Power	On Off	Power is supplied to the router. Power is not supplied to the router.
 Internet	On Blink	The Internet (Wide Area Network) port has detected a link with an attached device. Data is being transmitted or received by the Internet port.
 Wireless	On	Indicates that the Wireless port is initialized.
 Local	On (Green) Blink (Green) On (Amber) Blink (Amber) Off	The Local (LAN) port has detected link with a 100 Mbps device. Data is being transmitted or received at 100 Mbps. The Local port has detected link with a 10 Mbps device. Data is being transmitted or received at 10 Mbps. No link is detected on this port.

## The Router's Rear Panel

The rear panel of the Model RP614 router contains the port connections listed below.



**Figure 1-2: WGR614 Rear Panel**

Viewed from left to right, the rear panel contains the following features:

- AC power adapter outlet
- Four Local (LAN) 10/100 Mbps Ethernet ports for connecting the router to the local PCs
- Internet (WAN) Ethernet port for connecting the router to a cable or DSL modem
- Factory Default Reset push button
- Wireless antenna



## Chapter 2

# Connecting the Router to the Internet

This chapter describes how to set up the router on your local area network (LAN) and connect to the Internet. You will find out how to configure your Model WGR614 Cable/DSL Wireless Router for Internet access using the Setup Wizard, or how to manually configure your Internet connection.

### What You Will Need Before You Begin

---

You need to prepare these three things before you begin:

1. Have active Internet service such as that provided by a cable or DSL broadband account.
2. Locate the Internet Service Provider (ISP) configuration information for your DSL account.
3. Connect the router to a cable or DSL modem and a computer as explained below.

### Cabling and Computer Hardware Requirements

To use the WGR614 router on your network, each computer must have an installed Ethernet Network Interface Card (NIC) and an Ethernet cable. If the computer will connect to your network at 100 Mbps, you must use a Category 5 (CAT5) cable such as the one provided with your router.

### Computer Network Configuration Requirements

The WGR614 includes a built-in Web Configuration Manager. To access the configuration menus on the WGR614, you must use a Java-enabled web browser program which supports HTTP uploads such as Microsoft Internet Explorer or Netscape Navigator. NETGEAR recommends using Internet Explorer or Netscape Navigator 4.0 or above. Free browser programs are readily available for Windows, Macintosh, or UNIX/Linux.

For the initial connection to the Internet and configuration of your router, you will need to connect a computer to the router which is set to automatically get its TCP/IP configuration from the router via DHCP.

**Note:** For help with DHCP configuration, please refer to [Appendix C, “Preparing Your Network”](#).

The cable or DSL modem broadband access device must provide a standard 10 Mbps (10BASE-T) or 100 Mbps (100BASE-TX) Ethernet interface.

## Internet Configuration Requirements

Depending on how your ISP set up your Internet account, you will need one or more of these configuration parameters to connect your router to the Internet:

- Host and Domain Names
- ISP Login Name and Password
- ISP Domain Name Server (DNS) Addresses
- Fixed IP Address which is also known as Static IP Address

## Where Do I Get the Internet Configuration Parameters?

There are several ways you can gather the required Internet connection information.

- Your ISP provides all the information needed to connect to the Internet. If you cannot locate this information, you can ask your ISP to provide it or you can try one of the options below.
- If you have a computer already connected using the active Internet access account, you can gather the configuration information from that computer.
  - For Windows 95/98/ME, open the Network control panel, select the TCP/IP entry for the Ethernet adapter, and click Properties. Record all the settings for each tab page.
  - For Windows 2000/XP, open the Local Area Network Connection, select the TCP/IP entry for the Ethernet adapter, and click Properties. Record all the settings for each tab page.
  - For Macintosh computers, open the TCP/IP or Network control panel. Record all the settings for each section.
- You may also refer to the *WGR614 Resource CD* for the NETGEAR Router ISP Guide which provides Internet connection information for many ISPs.

Once you locate your Internet configuration parameters, you may want to record them on the page below.

## Record Your Internet Connection Information

Print this page. Fill in the configuration parameters from your Internet Service Provider (ISP).

**ISP Login Name:** The login name and password are case sensitive and must be entered exactly as given by your ISP. For AOL customers, the login name is their primary screen name. Some ISPs use your full e-mail address as the login name. The Service Name is not required by all ISPs. If you connect using a login name and password, then fill in the following:

Login Name: \_\_\_\_\_

Password: \_\_\_\_\_

Service Name: \_\_\_\_\_

**Fixed or Static IP Address:** If you have a static IP address, record the following information. For example, 169.254.141.148 could be a valid IP address.

Fixed or Static Internet IP Address: \_\_\_\_\_ . \_\_\_\_\_ . \_\_\_\_\_ . \_\_\_\_\_

Gateway IP Address: \_\_\_\_\_ . \_\_\_\_\_ . \_\_\_\_\_ . \_\_\_\_\_

Subnet Mask: \_\_\_\_\_ . \_\_\_\_\_ . \_\_\_\_\_ . \_\_\_\_\_

**ISP DNS Server Addresses:** If you were given DNS server addresses, fill in the following:

Primary DNS Server IP Address: \_\_\_\_\_ . \_\_\_\_\_ . \_\_\_\_\_ . \_\_\_\_\_

Secondary DNS Server IP Address: \_\_\_\_\_ . \_\_\_\_\_ . \_\_\_\_\_ . \_\_\_\_\_

**Host and Domain Names:** Some ISPs use a specific host or domain name like **CCA7324-A** or **home**. If you haven't been given host or domain names, you can use the following examples as a guide:

- If your main e-mail account with your ISP is **aaa@yyy.com**, then use **aaa** as your host name. Your ISP might call this your account, user, host, computer, or system name.
- If your ISP's mail server is **mail.xxx.yyy.com**, then use **xxx.yyy.com** as the domain name.

ISP Host Name: \_\_\_\_\_ ISP Domain Name: \_\_\_\_\_

**For Wireless Access:** For configuration of the wireless network, record the following:

Wireless Network Name (SSID): \_\_\_\_\_

Encryption (circle one): WEP 64, or WEP 128

WEP passphrase or key: \_\_\_\_\_

## Connecting the WGR614 to Your LAN

---

This section provides instructions for connecting the WGR614 router. Also, the *Model WGR614 Resource CD* included with your router contains an animated Installation Assistant to help you through this procedure.

### Connecting the Router

There are three steps to connecting your router:

1. Connect the router to your network
2. Log in to the router
3. Connect to the Internet

Follow the steps below to connect your router to your network. You can also refer to the Resource CD included with your router which contains an animated Installation Assistant to help you through this procedure.

#### 1. Connect the router to your network.

- a. Turn off your computer and Cable or DSL Modem.
- b. Disconnect the Ethernet cable (A) from your computer which connects to your cable or DSL modem.

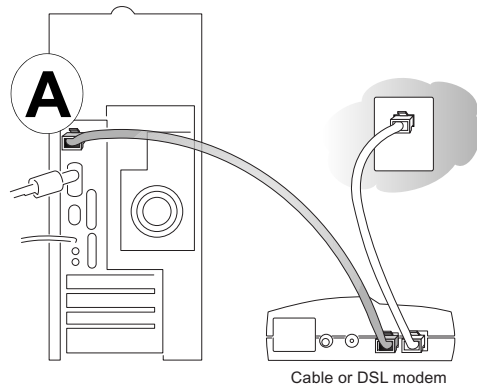
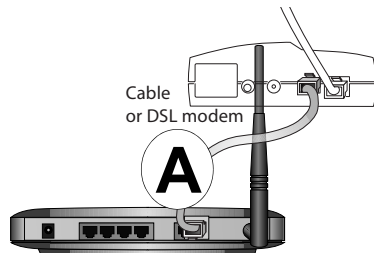

**Figure 2-1: Disconnect the cable or DSL Modem**

- c. Connect the Ethernet cable from your cable or DSL modem to the Internet port (A) on the WGR614.



**Note:** Place the WGR614 router in a location which conforms to the “[Observe Performance, Placement, and Range Guidelines](#)” on page 3-1. The stand provided with the WGR614 provides a convenient, space-saving way of installing the router. Avoid stacking it on other electronic equipment.



**Figure 2-2: Connect the cable or DSL Modem to the router**

- d. Connect the Ethernet cable which came with the router from a Local port on the router (B) to your computer.

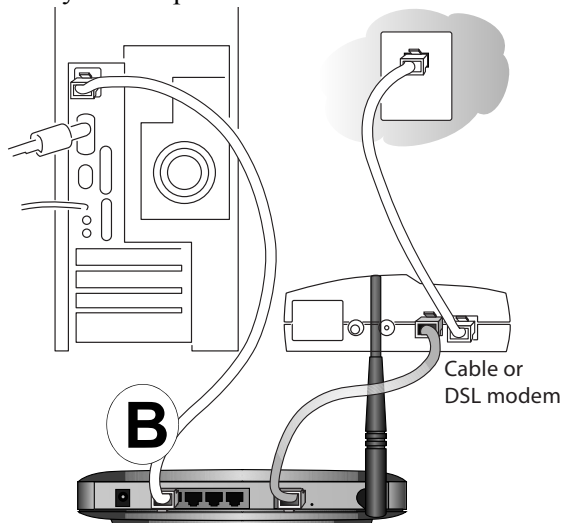



**Figure 2-3: Connect the computers on your network to the router**

**Note:** The WGR614 router incorporates Auto Uplink™ technology. Each LOCAL Ethernet port will automatically sense if the cable should have a normal connection or an uplink connection. This feature eliminates the need to worry about crossover cables because Auto Uplink will make the right connection either type of cable.

- e. Now, turn on your computer. If software usually logs you in to your Internet connection, do not run that software or cancel it if it starts automatically.
- f. Verify the following:

When you turn the router on, the power light  goes on.

The router's local LAN lights  are lit for any computers that are connected to it.

The router's Internet light  is lit, indicating a link has been established to the cable or DSL modem.

**Note:** For wireless placement and range guidelines, and wireless configuration instructions, please see [Chapter 3, "Wireless Configuration."](#)

## 2. Log in to the router.

**Note:** To connect to the router, your computer needs to be configured to obtain an IP address automatically via DHCP. If you need instructions on how to do this, please refer to [Appendix C, "Preparing Your Network"](#).

- a. Connect to the router by typing <http://192.168.0.1> in the address field of Internet Explorer or Netscape® Navigator.

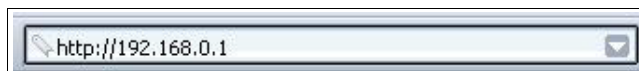
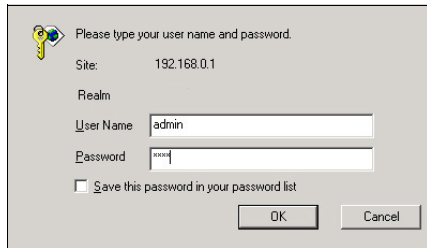

**Figure 2-4: Log in to the router**

- b. For security reasons, the router has its own user name and password. When prompted, enter **admin** for the router user name and **password** for the router password, both in lower case letters.

**Note:** The router user name and password are not the same as any user name or password you may use to log in to your Internet connection.

A login window like the one shown below opens:



**Figure 2-5: Login window**

### 3. Connect to the Internet

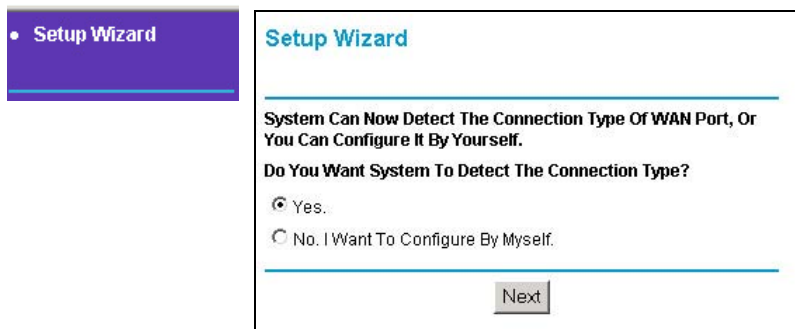

**Figure 2-6: Setup Smart Wizard**

- a. You are now connected to the router. If you do not see the menu above, click the Setup Smart Wizard link on the upper left of the main menu.
- b. Click Next and follow the steps in the Setup Smart Wizard for inputting the configuration parameters from your ISP to connect to the Internet.

**Note:** If you choose not to use the Setup Smart Wizard, you can manually configure your Internet connection settings by following the procedure [“How to Manually Configure Your Internet Connection”](#) on page 2-12.

Unless your ISP automatically assigns your configuration automatically via DHCP, you will need the configuration parameters from your ISP that you recorded in the form, [“Record Your Internet Connection Information”](#) on page 2-3.

- c. When the router successfully detects an active Internet service, the router's Internet LED goes on. The Setup Smart Wizard reports which connection type it discovered, and displays the appropriate configuration menu. If the Setup Smart Wizard finds no connection, you will be prompted to check the physical connection between your router and the cable or DSL line.
- d. The Setup Smart Wizard will report the type of connection it finds. The options are:
  - Connections which require a login using protocols such as PPPoE, PPTP, Telstra, or Bigpond broadband connections.
  - Connections which use dynamic IP address assignment.
  - Connections which use fixed IP address assignment.

The procedures for filling in the configuration menu for each type of connection follow below.

## PPPoE Smart Wizard-Detected Option

If the Setup Smart Wizard discovers that your ISP uses PPPoE, you will see this menu:

The screenshot shows a configuration window for PPPoE. It has a title bar with 'PPPoE' in blue. Below the title bar are several sections separated by horizontal lines. The first section has 'Account Name' and 'Domain Name' labels next to empty text input boxes. The second section has 'Login' and 'Password' labels next to empty text input boxes. The third section has 'Idle Timeout' label next to a text input box containing the number '5'. The fourth section is titled 'Domain Name Server (DNS) Address' and contains two radio buttons: 'Get automatically from ISP' (which is selected) and 'Use these DNS servers'. Below the radio buttons are two text input boxes labeled 'Primary DNS' and 'Secondary DNS'. At the bottom of the window are three buttons: 'Apply', 'Cancel', and 'Test'.

**Figure 2-7: Setup Smart Wizard menu for PPPoE accounts**

- Enter the Account Name, Domain Name, Login, and Password as provided by your ISP. These fields are case sensitive. The router will try to discover the domain automatically if you leave the Domain Name blank. Otherwise, you may need to enter it manually.

- To change the login timeout, enter a new value in minutes. This determines how long the router keeps the Internet connection active after there is no Internet activity from the LAN. Entering a timeout value of zero means never log out.

**Note:** You no longer need to run the ISP's login program on your PC in order to access the Internet. When you start an Internet application, your router will automatically log you in.

- If you know that your ISP does not automatically transmit DNS addresses to the router during login, select "Use these DNS servers" and enter the IP address of your ISP's Primary DNS Server. If a Secondary DNS Server address is available, enter it also.

**Note:** If you enter DNS addresses, restart your computers so that these settings take effect.

- Click Apply to save your settings.
- Click Test to verify that your Internet connection works. If the NETGEAR website does not appear within one minute, refer to [Chapter 7, "Troubleshooting."](#)

## Telstra Bigpond Cable Smart Wizard-Detected Option

If the Setup Wizard discovers Telstra Bigpond Cable is your ISP, you will see this menu:

**Telstra Bigpond Cable**

Login

Password

Authentication Server

**Domain Name Server (DNS) Address**

Get automatically from ISP

Use these DNS servers

Primary DNS

Secondary DNS

**Router MAC Address**

Use Default MAC Address

Use Computer MAC Address

Use This MAC Address

Apply Cancel Test

**Figure 2-8: Setup Smart Wizard menu for Telstra Bigpond Cable accounts**

- Enter your Login, Password and Authentication Server. These fields are case sensitive.

**Note:** You will no longer need to launch the ISP's login program on your PC in order to access the Internet. When you start an Internet application, your router will automatically log you in.

- The Domain Name Server (DNS) Address parameters may be necessary to access your ISP's services such as mail or news servers.

**Note:** If you enter DNS addresses, restart your computers so that these settings take effect.

- Router MAC Address. This section determines the Ethernet MAC address that will be used by the router on the Internet port. Some ISPs will register the Ethernet MAC address of the network interface card in your PC when your account is first opened. They will then only accept traffic from the MAC address of that PC. This feature allows your router to masquerade as that PC.

To change the MAC address, select "Use this Computer's MAC address." The router will then capture and use the MAC address of the PC that you are now using. You must be using the one PC that is allowed by the ISP. Or, select "Use this MAC address" and enter it.

- Click Apply to save your settings.
- Click Test to test your Internet connection. If the NETGEAR website does not appear within one minute, refer to [Chapter 7, "Troubleshooting"](#).

## Dynamic IP Smart Wizard-Detected Option

If the Setup Wizard discovers that your ISP uses Dynamic IP assignment, you will see this menu:

The screenshot shows a web-based configuration window titled "Dynamic IP". It has a light blue header. Below the header are two text input fields: "Account Name (If Required)" and "Domain Name (If Required)". A horizontal line separates this from the "Domain Name Server (DNS) Address" section. This section contains two radio buttons: "Get Automatically From ISP" (which is selected) and "Use These DNS Servers". Under "Use These DNS Servers", there are two rows of IP address input fields: "Primary DNS" and "Secondary DNS", each with four small boxes for the octets. At the bottom of the window are three buttons: "Apply", "Cancel", and "Test".

**Figure 2-9: Setup Smart Wizard menu for Dynamic IP address accounts**

- Enter your Account Name (may also be called Host Name) and Domain Name. These parameters may be necessary to access your ISP's services such as mail or news servers. If you leave the Domain Name field blank, the router try to discover the domain. Otherwise, you may need to enter it manually.
- If you know that your ISP does not automatically transmit DNS addresses to the router during login, select Use these DNS servers and enter the IP address of your ISP's Primary DNS Server. If a Secondary DNS Server address is available, enter it also.  
**Note:** If you enter DNS addresses, restart your computers so that these settings take effect.
- Click Apply to save your settings.
- Click Test to test your Internet connection. If the NETGEAR website does not appear within one minute, refer to [Chapter 7, "Troubleshooting."](#)

## Fixed IP Account Smart Wizard-Detected Option

If the Setup Wizard discovers that your ISP uses Fixed IP assignment, you will see this menu:

**Fixed IP**

---

**Internet IP Address**

IP Address: [0] [0] [0] [0]

IP Subnet Mask: [255] [255] [255] [0]

Gateway IP Address: [0] [0] [0] [0]

---

**Domain Name Server (DNS) Address**

Primary DNS: [0] [0] [0] [0]

Secondary DNS: [0] [0] [0] [0]

[Apply] [Cancel] [Test]

**Figure 2-10: Setup Smart Wizard menu for Fixed IP address accounts**

- Fixed IP is also called Static IP. Enter your assigned IP Address, Subnet Mask, and the IP Address of your ISP's gateway router. This information should have been provided to you by your ISP. Refer to the configuration parameters from your ISP you recorded in ["Record Your Internet Connection Information"](#) on page 2-3.
- Enter the IP address of your ISP's Primary and Secondary DNS Server addresses.  
**Note:** Restart the computers on your network so that these settings take effect.
- Click Apply to save the settings.

- Click Test to test your Internet connection. If the NETGEAR website does not appear within one minute, refer to [Chapter 7, “Troubleshooting.”](#)

## How to Manually Configure Your Internet Connection

You can manually configure your router using the menu below, or you can allow the Setup Wizard to determine your configuration as described in the previous section.

### ISP Does Not Require Login

**Basic Settings**

Does Your Internet Connection Require A Login?

Yes

No

Account Name (If Required)

Domain Name (If Required)

**Internet IP Address**

Get Dynamically From ISP

Use Static IP Address

IP Address

IP Subnet Mask

Gateway IP Address

**Domain Name Server (DNS) Address**

Get Automatically From ISP

Use These DNS Servers

Primary DNS

Secondary DNS

**Router MAC Address**

Use Default MAC Address

Use Computer MAC Address

Use This MAC Address

### ISP Does Require Login

**Basic Settings**

Does Your Internet Connection Require A Login?

Yes

No

Internet Service Provider

**Login**

**Password**

Service Name (If Required)

Idle Timeout (In Minutes)

**Domain Name Server (DNS) Address**

Get Automatically From ISP

Use These DNS Servers

Primary DNS

Secondary DNS

Figure 2-11: Browser-based configuration Basic Settings menus



You can manually configure the router using the Basic Settings menu shown in [Figure 2-11](#) using these steps:

1. Click the Basic Settings link on the Setup menu.
2. If your Internet connection does not require a login, click No at the top of the Basic Settings menu and fill in the settings according to the instructions below. If your Internet connection does require a login, click Yes, and skip to step 3.
  - a. Enter your Account Name (may also be called Host Name) and Domain Name.  
These parameters may be necessary to access your ISP's services such as mail or news servers.
  - b. Internet IP Address:  
If your ISP has assigned you a permanent, fixed (static) IP address for your PC, select "Use static IP address". Enter the IP address that your ISP assigned. Also enter the netmask and the Gateway IP address. The Gateway is the ISP's router to which your router will connect.
  - c. Domain Name Server (DNS) Address:  
If you know that your ISP does not automatically transmit DNS addresses to the router during login, select "Use these DNS servers" and enter the IP address of your ISP's Primary DNS Server. If a Secondary DNS Server address is available, enter it also.  
**Note:** If you enter an address here, restart the computers on your network so that these settings take effect.
  - d. Gateway's MAC Address:  
This section determines the Ethernet MAC address that will be used by the router on the Internet port. Some ISPs will register the Ethernet MAC address of the network interface card in your PC when your account is first opened. They will then only accept traffic from the MAC address of that PC. This feature allows your router to masquerade as that PC by "cloning" its MAC address.  
  
To change the MAC address, select "Use this Computer's MAC address." The router will then capture and use the MAC address of the PC that you are now using. You must be using the one PC that is allowed by the ISP. Or, select "Use this MAC address" and enter it.
  - e. Click Apply to save your settings.
3. If your Internet connection does require a login, fill in the settings according to the instructions below. Select Yes if you normally must launch a login program such as Enternet or WinPOET in order to access the Internet.

**Note:** After you finish setting up your router, you will no longer need to launch the ISP's login program on your PC in order to access the Internet. When you start an Internet application, your router will automatically log you in.

- a. Select your Internet service provisory from the drop-down list.

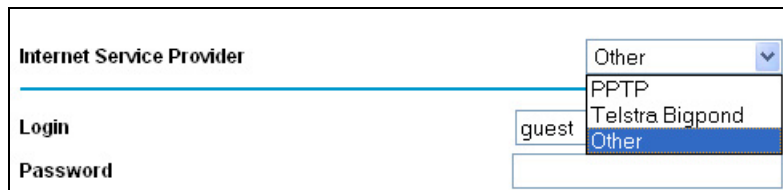

The screenshot shows a configuration window with the following elements:

- Internet Service Provider:** A dropdown menu with a blue arrow pointing down. The menu is open, showing a list of options: "Other", "PPTP", "Telstra Bigpond", and "Other". The second "Other" option is highlighted in blue.
- Login:** A text input field containing the text "guest".
- Password:** An empty text input field.

**Figure 2-12: Basic Settings ISP list**

- b. The screen will change according to the ISP settings requirements of the ISP you select.
- c. Fill in the parameters for your ISP according to the Wizard-detected procedures starting on [page 2-8](#).
- d. Click Apply to save your settings.

# Chapter 3

## Wireless Configuration

This chapter describes how to configure the wireless features of your WGR614 router. In planning your wireless network, you should consider the level of security required. You should also select the physical placement of your firewall in order to maximize the network speed. For further information on wireless networking, refer to in [Appendix D, “Wireless Networking Basics.”](#)

### Observe Performance, Placement, and Range Guidelines

---

The operating distance or range of your wireless connection can vary significantly based on the physical placement of the wireless firewall. The latency, data throughput performance, and notebook power consumption of wireless adapters also vary depending on your configuration choices.



**Note:** Failure to follow these guidelines can result in significant performance degradation or inability to wirelessly connect to the router. For complete range/performance specifications, please see [Appendix A, “Technical Specifications.”](#)

For best results, place your firewall:

- Near the center of the area in which your PCs will operate.
- In an elevated location such as a high shelf where the wirelessly connected PCs have line-of-sight access (even if through walls).
- Away from sources of interference, such as PCs, microwaves, and 2.4 GHz cordless phones.
- Away from large metal surfaces.

The time it takes to establish a wireless connection can vary depending on both your security settings and placement. WEP connections can take slightly longer to establish. Also, WEP encryption can consume more battery power on a notebook PC.

## Implement Appropriate Wireless Security



**Note:** Indoors, computers can connect over 802.11b/g wireless networks at ranges of up to 500 feet. Such distances can allow for others outside of your immediate area to access your network.

Unlike wired network data, your wireless data transmissions can be received well beyond your walls by anyone with a compatible adapter. For this reason, use the security features of your wireless equipment. The WGR614 router provides highly effective security features which are covered in detail in this chapter. Deploy the security features appropriate to your needs.

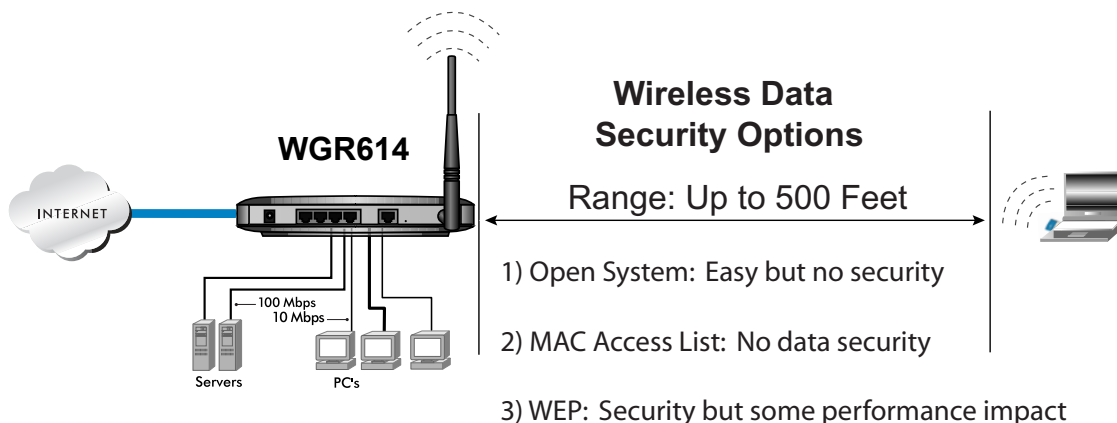

**Figure 3-1: WGR614 wireless data security options**

There are several ways you can enhance the security of your wireless network.

- **Restrict Access Based on MAC Address.** You can restrict access to only trusted PCs so that unknown PCs cannot wirelessly connect to the WGR614. MAC address filtering adds an obstacle against unwanted access to your network, but the data broadcast over the wireless link is fully exposed.
- **Turn Off the Broadcast of the Wireless Network Name SSID.** If you disable broadcast of the SSID, only devices that have the correct SSID can connect. This nullifies the wireless network 'discovery' feature of some products such as Windows XP, but the data is still fully exposed to a determined snoop using specialized test equipment like wireless sniffers.
- **WEP.** Wired Equivalent Privacy (WEP) data encryption provides data security. WEP Shared Key authentication and WEP data encryption will block all but the most determined eavesdropper.

- **Turn Off the Wired LAN.** If you disable the wireless LAN, wireless devices cannot communicate with the router at all. You might choose to turn off the wireless the LAN when you are away and the others in the household all use wired connections.

## Understanding Wireless Settings

To configure the Wireless settings of your firewall, click the Wireless link in the main menu of the browser interface. The Wireless Settings menu will appear, as shown below.

The screenshot shows the 'Wireless Settings' configuration page. It is divided into several sections:

- Wireless Network:** Includes fields for Name (SSID) set to 'Earl', Region set to 'United States', Channel set to '11', and Mode set to 'g and b'.
- Wireless Access Point:** Contains two checked checkboxes: 'Enable Wireless Access Point' and 'Allow Broadcast of Name (SSID)'.
- Wireless Card Access List:** Features a 'Setup Access List' button.
- Security Encryption (WEP):** Shows 'Authentication Type' set to 'Automatic' and 'Encryption Strength' set to 'Disable'.
- Security Encryption (WEP) Key:** Includes a 'Passphrase' field with a 'Generate' button, and four radio buttons labeled 'Key 1' through 'Key 4', each with an associated text input field.

At the bottom of the form are 'Apply' and 'Cancel' buttons.

Figure 3-2: Wireless Settings menu

## Common Wireless Settings

---



**Note:** The 802.11b and 802.11g wireless networking protocols are configured in exactly the same fashion. The WGR614 will automatically adjust to the 802.11g or 802.11b protocol as the device requires without compromising the speed of the other connected devices.

The 802.11b and g wireless network settings are mostly the same. The settings common to both the 802.11b and g protocols in the Wireless Settings menu are discussed below.

- **Name (SSID).** The SSID is also known as the wireless network name. Enter a value of up to 32 alphanumeric characters. In a setting where there is more than one wireless network, different wireless network names provide a means for separating the traffic. Any device you want to participate in a particular wireless network will need to use this SSID for that network. The WGR614 default SSID is: **NETGEAR**.
- **Region.** This field identifies the region where the WGR614 can be used. It may not be legal to operate the wireless features of the router in a region other than one of those identified in this field.
- **Channel.** This field determines which operating frequency will be used. It should not be necessary to change the wireless channel unless you notice interference problems with another nearby access point. For more information on the wireless channel frequencies please refer to [“Wireless Channels” on page D-7](#).
- **Mode.** This field determines which data communications protocol will be used. You can select “g only” or “g and b.” “g only” dedicates the WGR614 to communicating with the higher bandwidth 802.11g wireless devices exclusively. The “g and b” mode provides backward compatibility with the slower 802.11b wireless devices while still enabling 802.11g communications.
- **Allow Broadcast of Name (SSID).** If you disable broadcast of the SSID, only devices that have the correct SSID can connect. Disabling SSID broadcast nullifies the wireless network ‘discovery’ feature of some products such as Windows XP.
- **Enable Wireless Access Point.** If you disable the wireless access point, wireless devices cannot connect to the WGR614.
- **Wireless Card Access List.** When the Trusted PCs Only radio button is selected, the WGR614 checks the MAC address of the wireless station and only allows connections to PCs identified on the trusted PCs list.

Although the types of settings described above are the same for either type of wireless network, the choices you make in each type of network can be different. For example, you can disable the SSID broadcast in your 802.11a wireless network but enable it in your 802.11b/g network.

## Understanding WEP Authentication and Encryption

Restricting wireless access to your network prevents intruders from connecting to your network. However, the wireless data transmissions are still vulnerable to snooping. Using the WEP data encryption settings described below will prevent a determined intruder from eavesdropping on your wireless data communications. Also, if you are using the Internet for such activities as purchases or banking, those Internet sites use another level of highly secure encryption called SSL. You can tell if a web site is using SSL because the web address begins with HTTPS rather than HTTP.

### Authentication Scheme Selection

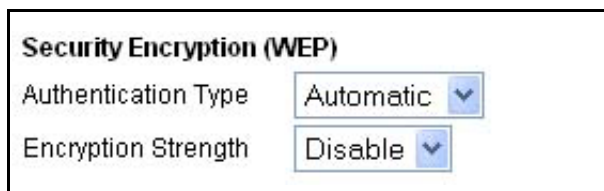

Security Encryption (WEP)

Authentication Type: Automatic

Encryption Strength: Disable

**Figure 3-3: Encryption Strength**

The WGR614 lets you select the following wireless authentication schemes.

- Automatic.
- Open System.
- Shared key.

	<p><b>Note:</b> The authentication scheme is separate from the data encryption. You can choose an authentication scheme which requires a shared key but still leave the data transmissions unencrypted. If you require strong security, use both the Shared Key and WEP encryption settings.</p>
---	--

Be sure to set your wireless adapter according to the authentication scheme you choose for the WGR614 router. Please refer to [“Authentication and WEP Data Encryption”](#) on page D-3 for a full explanation of each of these options, as defined by the IEEE 802.11 wireless communication standard.

## Encryption Strength Choices

Choose the encryption strength from the drop-down list. Please refer to [“Overview of WEP Parameters” on page D-5](#) for a full explanation of each of these options, as defined by the IEEE 802.11 wireless communication standard.

- **Disable.** No encryption will be applied. This setting is useful for troubleshooting your wireless connection, but leaves your wireless data fully exposed.
- **64-bit or 128-bit WEP.** When 64-bit or 128-bit is selected, WEP encryption will be applied.

If WEP is enabled, you can manually or automatically program the four data encryption keys. These values must be identical on all PCs and access points in your network.

There are two methods for creating WEP encryption keys:

- **Passphrase.** Enter a word or group of printable characters in the Passphrase box and click the Generate button. These characters *are* case sensitive.
- **Manual.** For 64-bit WEP, enter 10 hexadecimal digits (any combination of 0-9, a-f, or A-F). For 128-bit WEP, enter 26 hexadecimal digits (any combination of 0-9, a-f, or A-F). These values *are not* case sensitive.

## Default Factory Settings

When you first receive your WGR614, the default factory settings are shown below. You can restore these defaults with the Factory Default Restore button on the rear panel. After you install the WGR614 router, use the procedures below to customize any of the settings to better meet your networking needs.

FEATURE	DEFAULT FACTORY SETTINGS
Wireless Access Point	<b>Enabled</b>
Wireless Access List (MAC Filtering)	<b>All wireless stations allowed</b>
SSID broadcast	<b>Enabled</b>
SSID	<b>NETGEAR</b>
11b/g RF Channel	<b>11</b>
Mode	<b>g and b</b>
Authentication Type	<b>Open System</b>
WEP	<b>Disabled</b>



## Before You Change the SSID and WEP Settings

Before customizing your wireless settings, print this form and record the following information. If your working with an existing wireless network, the person who set up or is responsible for the network will be able to provide this information. Otherwise, you will choose the settings for your wireless network. Either way, record the settings for your wireless network in the spaces below.

- **Network Name (SSID):** The Service Set Identification (SSID), called the wireless network name in Windows XP, identifies the wireless network. You may use up to 32 alphanumeric characters. Record your customized SSID on the line below.

**Name (SSID):** \_\_\_\_\_

**Note:** The SSID in the router is the SSID you configure in the wireless adapter card. For the access point and wireless nodes to communicate with each other, all must be configured with the same SSID.

- **Authentication.** The authentication setting, “Open System” or “Shared Key,” is unrelated to encryption of transmissions. The two bands can use different authentication settings. Choose “Shared Key” for more security, circle one: Open System or Shared Key

**Note:** If you select shared key, the other devices in the network will not connect unless they are set to Shared Key as well.

- **WEP Encryption Strength.** Choose the key size. Circle one: **64** or **128** bits.
- **WEP Encryption Keys.**

There are two methods for creating WEP encryption keys:

- **Passphrase.** \_\_\_\_\_ Enter a word or group of printable characters. These characters *are* case sensitive. When you enter the Passphrase and click the Generate button on the WGR614, the keys will be generated.
- **Manual.** For 64-bit WEP, enter 10 hexadecimal digits (any combination of 0-9 or a-f). These values *are not* case sensitive. For 128-bit WEP, enter 26 hexadecimal digits.

Whichever method you use, record the key values in the spaces below.

Key 1: \_\_\_\_\_

Key 2: \_\_\_\_\_

Key 3: \_\_\_\_\_

Key 4: \_\_\_\_\_

Use the procedures described in the following sections to configure the WGR614. Store this information in a safe place.

## How to Set Up and Test Basic Wireless Connectivity

Follow the instructions below to set up and test basic wireless connectivity. Once you have established basic wireless connectivity, you can enable security settings appropriate to your needs.

1. Log in to the WGR614 firewall at its default LAN address of <http://192.168.0.1> with its default user name of **admin** and default password of **password**, or using whatever LAN address and password you have set up.
2. Click the Wireless Settings link in the main menu of the WGR614 firewall.



The screenshot shows the 'Wireless Settings' page. It has a title bar 'Wireless Settings' in blue. Below it is a section titled 'Wireless Network'. There are three input fields: 'Name (SSID):' with the text 'Earl', 'Region:' with a dropdown menu currently showing 'United States', and 'Channel:' with a dropdown menu currently showing '11'.

**Figure 3-4: Wireless Settings menu**

3. Choose a suitable descriptive name for the wireless network name (SSID). In the SSID box, enter a value of up to 32 alphanumeric characters. The default SSID is NETGEAR.  
**Note:** The SSID of any wireless access adapters must match the SSID you configure in the Model WGR614 Cable/DSL Wireless Router. If they do not match, you will not get a wireless connection to the WGR614.
4. Set the Region. Select the region in which the wireless interface will operate.
5. Set the Channel. The default channel is 11.  
This field determines which operating frequency will be used. It should not be necessary to change the wireless channel unless you notice interference problems with another nearby wireless router or access point. Select a channel that is not being used by any other wireless networks within several hundred feet of your firewall. For more information on the wireless channel frequencies please refer to [“Wireless Channels” on page D-7](#).
6. For initial configuration and test, leave the Wireless Card Access List set to “Everyone” and the Encryption Strength set to “Disabled.”
7. Click Apply to save your changes.



**Note:** If you are configuring the firewall from a wireless PC and you change the firewall's SSID, channel, or security settings, you will lose your wireless connection when you click on Apply. You must then change the wireless settings of your PC to match the firewall's new settings.

8. Configure and test your PCs for wireless connectivity.

Program the wireless adapter of your PCs to have the same SSID and channel that you configured in the router. Check that they have a wireless link and are able to obtain an IP address by DHCP from the firewall.

Once your PCs have basic wireless connectivity to the firewall, then you can configure the advanced wireless security functions of the firewall.

## How to Restrict Wireless Access by MAC Address

To restrict access based on MAC addresses, follow these steps:

1. Log in to the WGR614 firewall at its default LAN address of <http://192.168.0.1> with its default user name of **admin** and default password of **password**, or using whatever LAN address and password you have set up.



**Note:** When configuring the firewall from a wireless PC whose MAC address is not in the Trusted PC list, if you select Turn Access Control On, you will lose your wireless connection when you click on Apply. You must then access the router from a wired PC or from a wireless PC which is on the access control list to make any further changes.

2. Click the Wireless Settings link in the main menu of the WGR614 firewall.

- From the Wireless Settings menu, click the Setup Access List button to display the Wireless Access menu shown below.

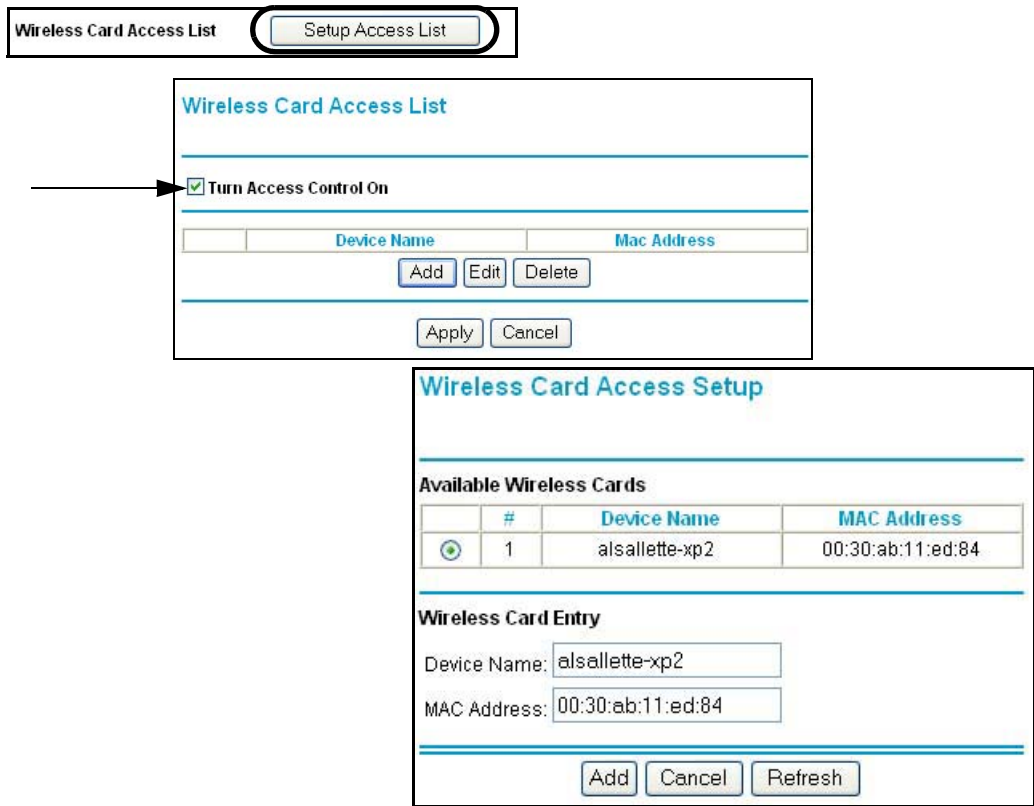

**Figure 3-5: Wireless Card Access List Setup**

- Click Add to add a wireless device to the wireless access control list. The Available Wireless Cards list displays.
  - Click the Turn Access Control On check box.
  - Then, either select from the list of available wireless cards the WGR614 has found in your area, or enter the MAC address and device name for a device you plan to use. You can usually find the MAC address printed on the wireless adapter.
- Note:** You can copy and paste the MAC addresses from the firewall’s Attached Devices menu into the MAC Address box of this menu. To do this, configure each wireless PC to obtain a wireless link to the firewall. The PC should then appear in the Attached Devices menu.
- Click Add to add this wireless device to the Wireless Card Access List. The screen changes back to the list screen. Repeat these steps for each additional device you wish to add to the list.
  - Be sure to click Apply to save your wireless access control list settings.

Now, only devices on this list will be allowed to wirelessly connect to the WGR614.

## How to Configure WEP

To configure WEP data encryption, follow these steps:

1. Log in to the WGR614 firewall at its default LAN address of <http://192.168.0.1> with its default user name of **admin** and default password of **password**, or using whatever LAN address and password you have set up.
2. Click the Wireless Settings link in the main menu of the WGR614 firewall.
3. From the Security Encryption menu drop-down list, select the WEP encryption type you will use.

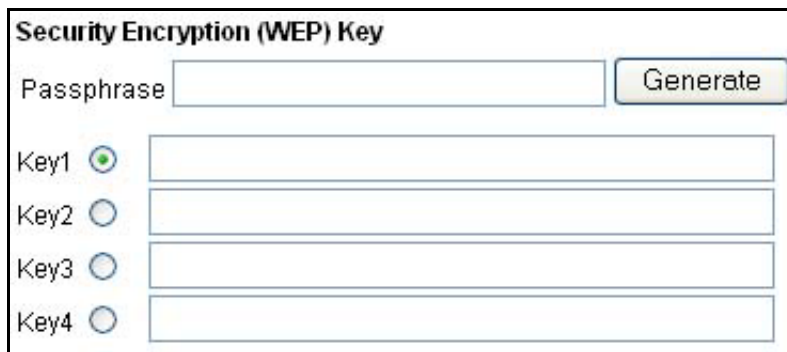

The screenshot shows a web interface titled "Security Encryption (WEP) Key". It contains a "Passphrase" text input field followed by a "Generate" button. Below this are four rows, each with a radio button and a text input field, labeled "Key1", "Key2", "Key3", and "Key4". The "Key1" radio button is selected.

**Figure 3-6. Wireless Settings encryption menu**

4. You can manually or automatically program the four data encryption keys. These values must be identical on all PCs and Access Points in your network.
  - Automatic - Enter a word or group of printable characters in the Passphrase box and click the Generate button. The four key boxes will be automatically populated with key values.
  - Manual - Enter ten hexadecimal digits (any combination of 0-9, a-f, or A-F)  
Select which of the four keys will be active.Please refer to [“Overview of WEP Parameters” on page D-5](#) for a full explanation of each of these options, as defined by the IEEE 802.11 wireless communication standard.
5. Click Apply to save your settings.

	<b>Note:</b> If you use a wireless PC configure WEP settings, you will be disconnected when you click on Apply. You must then either configure your wireless adapter to match the router WEP settings or access the router from a wired PC to make any further changes.
---	---



# Chapter 4

## Content Filtering

This chapter describes how to use the content filtering features of the Model WGR614 Cable/DSL Wireless Router to protect your network. These features can be found by clicking on the Content Filtering heading in the Main Menu of the browser interface.

### Content Filtering Overview

---

The Model WGR614 Cable/DSL Wireless Router provides you with Web content filtering options, plus browsing activity reporting and instant alerts via e-mail. Parents and network administrators can establish restricted access policies based on time-of-day, web addresses and web address keywords. You can also block Internet access by applications and services, such as chat or games. To configure these features of your router, click on the subheadings under the Content Filtering heading in the Main Menu of the browser interface. The subheadings are described below:

## Blocking Access to Internet Sites

---

The WGR614 router allows you to restrict access based on web addresses and web address keywords. Up to 255 entries are supported in the Keyword list. The Block Sites menu is shown in [Figure 4-1](#) below:

The screenshot shows the 'Block Sites' configuration page. At the top, the title 'Block Sites' is displayed in blue. Below the title, there is a section for 'Keyword Blocking' with three radio button options: 'Never' (selected), 'Per Schedule', and 'Always'. A horizontal line separates this from the next section, which prompts the user to 'Type keyword or domain name here.' with an input field and an 'Add Keyword' button. Another horizontal line follows, leading to a section titled 'Block sites containing these keywords or domain names:' with a list box containing the keyword 'discodanny'. Below the list box are 'Delete Keyword' and 'Clear List' buttons. A third horizontal line is followed by a checkbox labeled 'Allow Trusted IP Address To Visit Blocked Sites', which is currently unchecked. Below this is a 'Trusted IP Address' field with four input boxes, each containing the digit '0'. At the bottom of the form are 'Apply' and 'Cancel' buttons.

**Figure 4-1: Block Sites menu**

To enable keyword blocking, select either “Per Schedule” or “Always”, then click Apply. If you want to block by schedule, be sure that a time period is specified in the Schedule menu.

To add a keyword or domain, type it in the Keyword box, click Add Keyword, then click Apply.

To delete a keyword or domain, select it from the list, click Delete Keyword, then click Apply.

Keyword application examples:

- If the keyword "XXX" is specified, the URL <http://www.badstuff.com/xxx.html> is blocked.



- If the keyword “.com” is specified, only websites with other domain suffixes (such as .edu or .gov) can be viewed.
- If you wish to block all Internet browsing access during a scheduled period, enter the keyword “.” and set the schedule in the Schedule menu.

To specify a Trusted User, enter that PC’s IP address in the Trusted User box and click Apply.

You may specify one Trusted User, which is a PC that will be exempt from blocking and logging. Since the Trusted User will be identified by an IP address, you should configure that PC with a fixed IP address.

## Blocking Access to Internet Services

---

The WGR614 router allows you to block the use of certain Internet services by PCs on your network. This is called services blocking or port filtering. The Block Services menu is shown below:

#	Service Type	Port	IP
1	HTTP	80-80	Every IP

**Figure 4-2: Block Services menu**

Services are functions performed by server computers at the request of client computers. For example, Web servers serve web pages, time servers serve time and date information, and game hosts serve data about other players’ moves. When a computer on your network sends a request for service to a server computer on the Internet, the requested service is identified by a service or port number. This number appears as the destination port number in the transmitted IP packets. For example, a packet that is sent with destination port number 80 is an HTTP (Web server) request.

To enable service blocking, select either Per Schedule or Always, then click Apply. If you want to block by schedule, be sure that a time period is specified in the Schedule menu.

To specify a service for blocking, click Add. The Add Services menu will appear, as shown below:

**Block Services**

Service Type: HTTP

Protocol: TCP

Starting Port: 80 (1~65535)

Ending Port: 80 (1~65535)

Service Type/User Defined: HTTP

Filter IP by:

Only this IP: 192 . 168 . 0 .

IP address range: 192 . 168 . 0 . to 192 . 168 . 0 .

Every IP

OK Cancel

**Figure 4-3: Add Services menu**

From the Service Type list, select the application or service to be allowed or blocked. The list already displays several common services, but you are not limited to these choices. To add any additional services or applications that do not already appear, select User Defined.

## Configuring a User Defined Service

To define a service, first you must determine which port number or range of numbers is used by the application. The service numbers for many common protocols are defined by the Internet Engineering Task Force (IETF) and published in RFC1700, “Assigned Numbers.” Service numbers for other applications are typically chosen from the range 1024 to 65535 by the authors of the application. This information can usually be determined by contacting the publisher of the application or from user groups of newsgroups.

Enter the Starting Port and Ending Port numbers. If the application uses a single port number, enter that number in both boxes.

If you know that the application uses either TCP or UDP, select the appropriate protocol. If you are not sure, select Both.

## Configuring Services Blocking by IP Address Range

Under “Filter Services For”, you can block the specified service for a single PC, a range of PCs (having consecutive IP addresses), or all PCs on your network.

## Scheduling When Blocking Will Be Enforced

---

The WGR614 router allows you to specify when blocking will be enforced. The Schedule menu is shown below:

The screenshot shows a web-based configuration page titled "Schedule". It contains two main sections: "Days To Block:" and "Time Of Day To Block: (use 24-hour clock)".

**Days To Block:** This section has a list of days with checkboxes next to them, all of which are checked: Every day, Sunday, Monday, Tuesday, Wednesday, Thursday, Friday, and Saturday.

**Time Of Day To Block: (use 24-hour clock)** This section has a checkbox for "All Day" which is checked. Below it are two rows of input fields: "Start Blocking:" and "End Blocking:". Each row has two input boxes for "Hour" and "Min", both containing the number "0".

At the bottom of the form are two buttons: "Apply" and "Cancel".

**Figure 4-4: Schedule menu**

Use this check boxes on this menu to create a schedule for blocking content. Click Apply.

- **Days to Block.** Select days to block by checking the appropriate boxes. Select Everyday to check the boxes for all days. Click Apply.
- **Time of Day to Block.** Select a start and end time in 23:59 format. Select All day for 24 hour blocking. Click Apply.

**Note:** Be sure to select your time zone in the E-Mail menu.

## Viewing Logs of Web Access or Attempted Web Access

The log is a detailed record of what websites you have accessed or attempted to access. Up to 128 entries are stored in the log. Log entries will only appear when keyword blocking is enabled, and no log entries will be made for the Trusted User. An example is shown below:

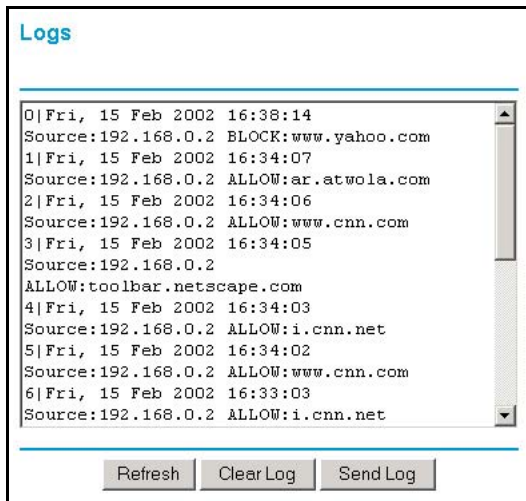

**Figure 4-5: Logs menu**

Log entries are described in [Table 4-1](#)

**Table 4-1. Log entry descriptions**

Field	Description
Number	The index number of the content filter log entries. 128 entries are available numbered from 0 to 127. The log will keep the record of the latest 128 entries.
Date and Time	The date and time the log entry was recorded.
Source IP	The IP address of the initiating device for this log entry.
Action	This field displays whether the access was blocked or allowed.
	The name or IP address of the website or newsgroup visited or attempted to access.

Log action buttons are described in [Table 4-2](#)

**Table 4-2. Log action buttons**

Field	Description
Refresh	Click this button to refresh the log screen.
Clear Log	Click this button to clear the log entries.
Send Log	Click this button to email the log immediately.

## Configuring E-Mail Alert and Web Access Log Notifications

In order to receive logs and alerts by email, you must provide your email information in the E-Mail menu, shown below:

**E-mail**

**Turn E-mail Notification On.**

---

**Send Alert And Logs Via E-mail**  
 Your Outgoing Mail Server:  
  
 Send To This E-mail Address:

---

**Send Alert Immediately**  
 When Someone Attempts To Visit Blocked Site.

---

Send Logs According To This Schedule  
  
  
  A.M.  P.M.

---

**Time Zone**  
  
 Adjust for Daylight Savings Time

**Current Time : 10:14:38, Fri.**

**Figure 4-6: Email menu**

- Turn e-mail notification on  
Check this box if you wish to receive e-mail logs and alerts from the router.
- Your outgoing mail server  
Enter the name of your ISP's outgoing (SMTP) mail server (such as mail.myISP.com). You may be able to find this information in the configuration menu of your e-mail program. If you leave this box blank, log and alert messages will not be sent via e-mail.
- Send to this e-mail address  
Enter the e-mail address to which logs and alerts are sent. This e-mail address will also be used as the From address. If you leave this box blank, log and alert messages will not be sent via e-mail.

You can specify that logs are automatically sent to the specified e-mail address with these options:

- Send alert immediately  
Check this box if you would like immediate notification of attempted access to a blocked site.
- Send logs according to this schedule  
Specifies how often to send the logs: None, Hourly, Daily, Weekly, or When Full.
  - Day for sending log. Specifies which day of the week to send the log. Relevant when the log is sent weekly or daily.
  - Time for sending log. Specifies the time of day to send the log. Relevant when the log is sent daily or weekly.

If the Weekly, Daily or Hourly option is selected and the log fills up before the specified period, the log is automatically e-mailed to the specified e-mail address. After the log is sent, the log is cleared from the router's memory. If the router cannot e-mail the log file, the log buffer may fill up. In this case, the router overwrites the log and discards its contents. If you don't want logs sent, select None from the list in the Send Logs According To This Schedule area. When you turn on e-mail notification and choose None in the Send Logs According to this Schedule list, the alert is sent but not the log.

The WGR614 router uses the Network Time Protocol (NTP) to obtain the current time and date from one of several Network Time Servers on the Internet. In order to localize the time for your log entries, you must specify your Time Zone:

- Time Zone. Select your local time zone. This setting will be used for the blocking schedule and for time-stamping log entries.
- Daylight Savings Time. Check this box if your time zone is currently under daylight savings time.

**Note:** If your region uses Daylight Savings Time, you must manually select Adjust for Daylight Savings Time on the first day of Daylight Savings Time, and unselect it at the end. Enabling Daylight Savings Time will cause one hour to be added to the standard time.

# Chapter 5 Maintenance

This chapter describes how to use the maintenance features of your Model WGR614 Cable/DSL Wireless Router. These features can be found by clicking on the Maintenance heading in the Main Menu of the browser interface.

## Viewing Router Status Information

---

The Router Status menu provides a limited amount of status and usage information. From the Main Menu of the browser interface, click on Maintenance, then select System Status to view the System Status screen, shown below.

Router Status	
Account Name	WGR614
Firmware Version	Version 1.0 Release 15
<b>Internet Port</b>	
MAC Address	00:09:5b:2d:67:9f
IP Address	67.117.94.53
DHCP	Fixed IP Address
IP Subnet Mask	255.255.255.0
Domain Name Server	64.115.0.9
<b>LAN Port</b>	
MAC Address	00:09:5b:2d:67:9e
IP Address	192.168.0.1
DHCP	On
IP Subnet Mask	255.255.255.0
<b>Wireless Port</b>	
Name (SSID)	Earl
Region	United States
Channel	11
Mode	g and b
Wireless AP	On
Broadcast Name	On
<input type="button" value="Show Statistics"/> <input type="button" value="Connection Status"/>	

Figure 5-1: Router Status screen

This screen shows the following parameters:

**Table 6. Menu 3.2 - Router Status Fields**

Field	Description
Account Name	This field displays the Host Name assigned to the router.
Firmware Version	This field displays the router firmware version.
Internet Port	These parameters apply to the Internet (WAN) port of the router.
MAC Address	This field displays the Media Access Control address being used by the Internet (WAN) port of the router.
IP Address	This field displays the IP address being used by the Internet (WAN) port of the router. If no address is shown, the router cannot connect to the Internet.
IP Subnet Mask	This field displays the IP Subnet Mask being used by the Internet (WAN) port of the router.
DHCP	If set to None, the router is configured to use a fixed IP address on the WAN. If set to Client, the router is configured to obtain an IP address dynamically from the ISP.
LAN Port	These parameters apply to the Local (WAN) port of the router.
MAC Address	This field displays the Media Access Control address being used by the LAN port of the router.
IP Address	This field displays the IP address being used by the Local (LAN) port of the router. The default is 192.168.0.1
DHCP	Identifies if the router's built-in DHCP server is active for the LAN attached devices.
IP Subnet Mask	This field displays the IP Subnet Mask being used by the Local (LAN) port of the router. The default is 255.255.255.0
Wireless Port	These parameters apply to the Wireless port of the router.
MAC Address	This field displays the Media Access Control address being used by the Wireless port of the router.
Name (SSID)	This field displays the wireless network name (SSID) being used by the wireless port of the router. The default is Wireless.
Region	This field displays the geographic region where the router being used. It may be illegal to use the wireless features of the router in some parts of the world.
Channel	Identifies if the channel the wireless port is using. See <a href="#">"Wireless Channels" on page D-7</a> for the frequencies used on each channel.



Click on the “Show WAN Status” button to display the WAN status, as shown below.

<b>Connection Time</b>	0:18:29
<b>Connection Method</b>	Dynamic IP
<b>IP Address</b>	0.0.0.0
<b>Network Mask</b>	0.0.0.0
<b>Default Gateway</b>	0.0.0.0
<input type="button" value="Renew"/>	

**Figure 6-1: Connection Status screen**

This screen shows the following statistics:.

**Table 7. Connection Status Fields**

Field	Description
Connection Time	The length of time the router has been connected to your Internet service provider’s network.
Connection Method	The method used to obtain an IP address from your Internet service provider.
IP Address	The WAN (Internet) IP Address assigned to the router.
Network Mask	The WAN (Internet) Subnet Mask assigned to the router.
Default Gateway	The WAN (Internet) default gateway the router communicates with.

WAN Status action buttons are described in [Table 8](#)

**Table 8. Show WAN Status action buttons**

Field	Description
Renew	Click the Renew button to renew the DHCP lease.

Click on the “Show Statistics” button to display router usage statistics, as shown below.

System Up Time 0:13:22							
Port	Status	TxPkts	RxPkts	Collisions	Tx B/s	Rx B/s	Up Time
WAN	10M/Half	52	0	0	118	0	0:13:22
LAN	100M/Full	959	728	0	1921	720	0:13:22
WLAN	11M	959	728	0	1921	720	0:13:22

Poll Interval:  (secs)           

**Figure 8-1: Router Statistics screen**

This screen shows the following statistics:

**Table 9. Router Statistics Fields**

Field	Description
Port	The statistics for the WAN (Internet) and LAN (local) ports. For each port, the screen displays:
Status	The link status of the port.
TxPkts	The number of packets transmitted on this port since reset or manual clear.
RxPkts	The number of packets received on this port since reset or manual clear.
Collisions	The number of collisions on this port since reset or manual clear.
Tx B/s	The current transmission (outbound) bandwidth used on the WAN and LAN ports.
Rx B/s	The current reception (inbound) bandwidth used on the WAN and LAN ports.
Up Time	The amount of time since the router was last restarted.
Up Time	The time elapsed since this port acquired the link.
Poll Interval	Specifies the intervals at which the statistics are updated in this window. Click on Stop to freeze the display.

Show Statistics action buttons are described in [Table 10](#)

**Table 10. Show Statistics action buttons**

Field	Description
Set Interval	Enter a time and click the button to set the polling frequency.
Stop	Click the Stop button to freeze the polling information.

## Viewing a List of Attached Devices

---

The Attached Devices menu contains a table of all IP devices that the router has discovered on the local network. From the Main Menu of the browser interface, under the Maintenance heading, select Attached Devices to view the table, shown below.

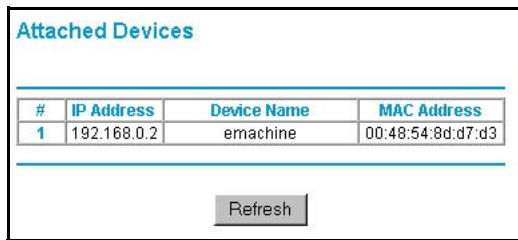

The screenshot shows a web interface titled "Attached Devices". It contains a table with the following data:

#	IP Address	Device Name	MAC Address
1	192.168.0.2	emachine	00:48:54:8d:d7:d3

Below the table is a "Refresh" button.

**Figure 10-1: Attached Devices menu**

For each device, the table shows the IP address, NetBIOS Host Name (if available), and Ethernet MAC address. Note that if the router is rebooted, the table data is lost until the router rediscovers the devices. To force the router to look for attached devices, click the Refresh button.

## Upgrading the Router Software

---

The routing software of the WGR614 router is stored in FLASH memory, and can be upgraded as new software is released by NETGEAR. Upgrade files can be downloaded from Netgear's website. If the upgrade file is compressed (.ZIP file), you must first extract the binary (.BIN) file before sending it to the router. The upgrade file can be sent to the router using your browser.

**Note:** The Web browser used to upload new firmware into the WGR614 router must support HTTP uploads. NETGEAR recommends using Microsoft Internet Explorer or Netscape Navigator 4.0 or above.

From the Main Menu of the browser interface, under the Maintenance heading, select the Router Upgrade heading to display the menu shown below.

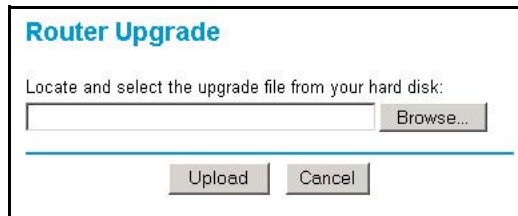

**Router Upgrade**

Locate and select the upgrade file from your hard disk:

Browse...

---

Upload Cancel

**Figure 10-2: Router Upgrade menu**

To upload new firmware:

1. Download and unzip the new software file from NETGEAR.
2. In the Router Upgrade menu, click the Browse button and browse to the location of the binary (.BIN) upgrade file
3. Click Upload.

**Note:** When uploading software to the WGR614 router, it is important not to interrupt the Web browser by closing the window, clicking a link, or loading a new page. If the browser is interrupted, it may corrupt the software. When the upload is complete, your router will automatically restart. The upgrade process will typically take about one minute.

In some cases, you may need to reconfigure the router after upgrading.

## Configuration File Management

---

The configuration settings of the WGR614 router are stored within the router in a configuration file. This file can be saved (backed up) to a user's PC, retrieved (restored) from the user's PC, or cleared to factory default settings.

From the Main Menu of the browser interface, under the Maintenance heading, select the Settings Backup heading to bring up the menu shown below.

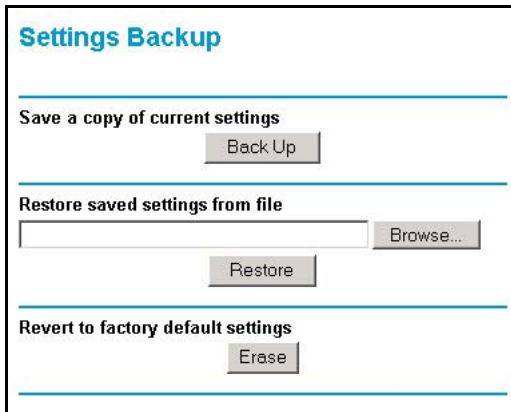

**Figure 10-3: Settings Backup menu**

Three options are available, and are described in the following sections.

## Restoring and Backing Up the Configuration

The Restore and Backup options in the Settings Backup menu allow you to save and retrieve a file containing your router's configuration settings.

To save your settings, select the Backup tab. Click the Backup button. Your browser will extract the configuration file from the router and will prompt you for a location on your PC to store the file. You can give the file a meaningful name at this time, such as pacbell.cfg.

To restore your settings from a saved configuration file, enter the full path to the file on your PC or click the Browse button to browse to the file. When you have located it, click the Restore button to send the file to the router. The router will then reboot automatically.

## Erasing the Configuration

It is sometimes desirable to restore the router to the factory default settings. This can be done by using the Erase function, which will restore all factory settings. After an erase, the router's password will be **password**, the LAN IP address will be 192.168.0.1, and the router's DHCP client will be enabled.

To erase the configuration, click the Erase button.

To restore the factory default configuration settings without knowing the login password or IP address, you must use the Default Reset button on the rear panel of the router. See [“Restoring the Default Configuration and Password” on page 7-7](#).

## Changing the Administrator Password

---

The default password for the router's Web Configuration Manager is **password**. Netgear recommends that you change this password to a more secure password.

From the Main Menu of the browser interface, under the Maintenance heading, select Set Password to bring up the menu shown below.



The screenshot shows a web form titled "Change Password" with three input fields: "Old password", "New password", and "Repeat new password". Below the fields are two buttons: "Apply" and "Cancel".

**Figure 10-4: Set Password menu**

To change the password, first enter the old password, and then enter the new password twice. Click Apply.

# Chapter 6

## Advanced Configuration

This chapter describes how to configure the advanced features of your Model WGR614 Cable/DSL Wireless Router. These features can be found under the Advanced heading in the Main Menu of the browser interface.

### Configuring Port Forwarding to Local Servers

---

Although the router causes your entire local network to appear as a single machine to the Internet, you can make a local server (for example, a web server or game server) visible and available to the Internet. This is done using the Port Forwarding menu. From the Main Menu of the browser interface, under Advanced, click on Port Forwarding to view the port forwarding menu, shown below.

#	Service Name	Start Port	End Port	Server IP Address
---	--------------	------------	----------	-------------------

**Figure 6-1: Port Forwarding Menu**



**Note:** If you are unfamiliar with networking and routing, refer to [Appendix B, “Network, Routing, Firewall, and Basics,”](#) to become more familiar with the terms and procedures used in this manual.

Use the Port Forwarding menu to configure the router to forward incoming protocols to computers on your local network. In addition to servers for specific applications, you can also specify a Default DMZ Server to which all other incoming protocols are forwarded. The DMZ Server is configured in the Security Menu.

Before starting, you'll need to determine which type of service, application or game you'll provide and the IP address of the computer that will provide each service. Be sure the computer's IP address never changes. To configure port forwarding to a local server:

1. From the Service Name box, select the service or game that you will host on your network. If the service does not appear in the list, refer to the following section, [“Adding a Port Forwarding Custom Service”](#).
2. Enter the IP address of the local server in the corresponding Server IP Address box.
3. Click the Add button.

## Adding a Port Forwarding Custom Service

To define a service, game or application that does not appear in the Service Name list, you must determine what port numbers are used by the service. For this information, you may need to contact the manufacturer of the program that you wish to use. When you have the port number information, follow these steps:

1. Click the Add Custom Service button.
2. Enter the first port number in an unused Starting Port box.
3. To forward only one port, enter it again in the Ending Port box. To specify a range of ports, enter the last port to be forwarded in the End Port box.
4. Enter the IP address of the local server in the corresponding Server IP Address box.
5. Type a name for the service.
6. Click Apply at the bottom of the menu.



## Editing or Deleting a Port Forwarding Entry

To edit or delete a Port Forwarding entry, follow these steps.

1. In the table, select the button next to the service name.
2. Click Edit or Delete.

## Local Web and FTP Server Example

If a local PC with a private IP address of 192.168.0.33 acts as a Web and FTP server, configure the Ports menu to forward HTTP (port 80) and FTP (port 21) to local address 192.168.0.33

In order for a remote user to access this server from the Internet, the remote user must know the IP address that has been assigned by your ISP. If this address is 172.16.1.23, for example, an Internet user can access your Web server by directing the browser to <http://172.16.1.23>. The assigned IP address can be found in the Maintenance Status Menu, where it is shown as the WAN IP Address.

Some considerations for this application are:

- If your account's IP address is assigned dynamically by your ISP, the IP address may change periodically as the DHCP lease expires.
- If the IP address of the local PC is assigned by DHCP, it may change when the PC is rebooted. To avoid this, you can manually configure the PC to use a fixed address.
- Local PCs must access the local server using the PCs' local LAN address (192.168.0.33 in this example). Attempts by local PCs to access the server using the external IP address (172.16.1.23 in this example) will fail.

## Multiple Computers for Half Life, KALI or Quake III Example

To set up an additional computer to play Half Life, KALI or Quake III:

1. Click the button of an unused port in the table.
2. Select the game again from the Service Name list.
3. Change the beginning port number in the Start Port box.  
For these games, use the supplied number in the default listing and add +1 for each additional computer. For example, if you've already configured one computer to play Hexen II (using port 26900), the second computer's port number would be 26901, and the third computer would be 26902.

4. Type the same port number in the End Port box that you typed in the Start Port box.
5. Type the IP address of the additional computer in the Server IP Address box.
6. Click Apply.

Some online games and videoconferencing applications are incompatible with NAT. The WGR614 router is programmed to recognize some of these applications and to work properly with them, but there are other applications that may not function well. In some cases, one local PC can run the application properly if that PC's IP address is entered as the default in the PORTS Menu. If one local PC acts as a game or videoconferencing host, enter its IP address as the default.

## Configuring WAN Setup Options

---

The WAN Setup options let you configure a DMZ server, change the MTU size and enable the router to respond to a Ping on the WAN port. These options are discussed below.

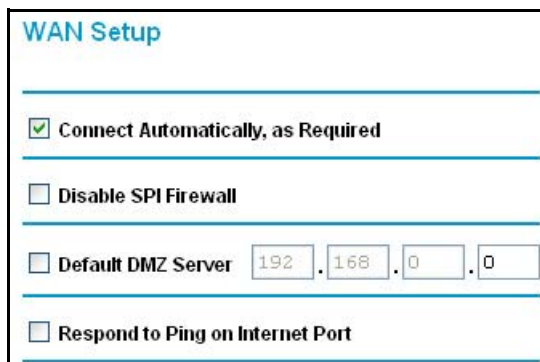

The screenshot shows the WAN Setup menu with the following options:

- Connect Automatically, as Required
- Disable SPI Firewall
- Default DMZ Server: 192 . 168 . 0 . 0
- Respond to Ping on Internet Port

Figure 6-2: WAN Setup menu.

- **Connect Automatically, as Required**

Normally, this option should be Enabled, so that an Internet connection will be made automatically, whenever Internet-bound traffic is detected. In locations where Internet access is billed by the minute, if this causes high connection costs, you can disable this setting.

If disabled, you must connect manually, using the sub-screen accessed from the Router Status menu "Show WAN Status" screen.

- **Disable SPI Firewall**

Normally, this option should be Enabled, so that your local network will be protected by the Stateful Packet Inspection (SPI) firewall included in the WGR614. However, certain communications functions like VPN may require turning off the SPI feature.

- **Setting Up a Default DMZ Server**

The default DMZ server feature is helpful when using some online games and videoconferencing applications that are incompatible with NAT. The router is programmed to recognize some of these applications and to work properly with them, but there are other applications that may not function well. In some cases, one local PC can run the application properly if that PC's IP address is entered as the default DMZ server.

	<b>Note:</b> DMZ servers pose a security risk. A computer designated as the default DMZ server loses much of the protection of the firewall, and is exposed to exploits from the Internet. If compromised, the DMZ server can be used to attack your network.
---	---

Incoming traffic from the Internet is normally discarded by the router unless the traffic is a response to one of your local computers or a service that you have configured in the Ports menu. Instead of discarding this traffic, you can have it forwarded to one computer on your network. This computer is called the Default DMZ Server.

The WAN Setup menu, shown below lets you configure a Default DMZ Server.

To assign a computer or server to be a Default DMZ server, follow these steps:

1. Click WAN Setup link on the Advanced section of the main menu.
2. Type the IP address for that server. To remove the default DMZ server, replace the IP address numbers with all zeros.
3. Click Apply.

- **Respond to Ping on Internet WAN Port**

If you want the router to respond to a 'ping' from the Internet, click the 'Respond to Ping on Internet WAN Port' check box. This should only be used as a diagnostic tool, since it allows your router to be discovered. Don't check this box unless you have a specific reason to do so.

- **Setting the MTU Size**

The default MTU size is usually fine. The normal MTU (Maximum Transmit Unit) value for most Ethernet networks is 1500 Bytes. For some ISPs, particularly some using PPPoE, you may need to reduce the MTU. This should not be done unless you are sure it is necessary for your ISP.

Any packets sent through the router that are larger than the configured MTU size will be repackaged into smaller packets to meet the MTU requirement. To change the MTU size:

Under MTU Size, enter a new size between 64 and 1500. Then, click Apply to save the new configuration.

## Using a Dynamic DNS Service

---

If your network has a permanently assigned IP address, you can register a domain name and have that name linked with your IP address by public Domain Name Servers (DNS). However, if your Internet account uses a dynamically assigned IP address, you will not know in advance what your IP address will be, and the address can change frequently. In this case, you can use a commercial dynamic DNS service which will allow you to register your domain to their IP address, and will forward traffic directed at your domain to whatever your current IP address happens to be.

	<p><b>Note:</b> If your ISP assigns a private WAN IP address (such as 192.168.x.x or 10.x.x.x), the dynamic DNS service will not work because private addresses will not be routed on the Internet.</p>
--	---

The router contains a client that can connect to many popular dynamic DNS services. You can select one of these services and obtain an account with them. Then, whenever your ISP-assigned IP address changes, your router will automatically contact your dynamic DNS service provider, log in to your account, and register your new IP address.

From the Main Menu of the browser interface, under Advanced, click on Dynamic DNS. To configure Dynamic DNS:

1. Register for an account with one of the dynamic DNS service providers whose names appear in the 'Select Service Provider' box. For example, for dyndns.org, go to [www.dyndns.org](http://www.dyndns.org).
2. Select the Use a Dynamic DNS service check box.
3. Select the name of your dynamic DNS Service Provider.
4. Type the Host Name (or domain name) that your dynamic DNS service provider gave you.
5. Type the User Name for your dynamic DNS account.
6. Type the Password (or key) for your dynamic DNS account.

7. If your dynamic DNS provider allows the use of wildcards in resolving your URL, you may select the Use wildcards check box to activate this feature.  
For example, the wildcard feature will cause \*.yourhost.dyndns.org to be aliased to the same IP address as yourhost.dyndns.org
8. Click Apply to save your configuration.

## Using LAN IP Setup Options

The LAN IP Setup feature is under the Advanced heading of the main menu. This feature allows configuration of LAN IP services such as DHCP and RIP. From the Main Menu of the browser interface, under Advanced, click on LAN IP Setup to view the LAN IP Setup menu, shown below.

The screenshot shows the 'LAN IP Setup' configuration page. It is divided into three main sections: 'LAN TCP/IP Setup', 'DHCP Server', and 'Address Reservation'.  
1. **LAN TCP/IP Setup:** Includes fields for IP Address (192.168.0.1), IP Subnet Mask (255.255.255.0), RIP Direction (Both), and RIP Version (RIP-1).  
2. **Use Router As DHCP Server:** A checked checkbox. Below it are fields for Starting IP Address (192.168.0.2) and Ending IP Address (192.168.0.50).  
3. **Address Reservation:** A table with columns for #, IP Address, Device Name, and MAC Address. Below the table are 'Add', 'Edit', and 'Delete' buttons.  
At the bottom of the form are 'Apply' and 'Cancel' buttons.

Figure 6-3: LAN IP Setup Menu

The router is shipped preconfigured to use private IP addresses on the LAN side, and to act as a DHCP server. The router's default LAN IP configuration is:

- LAN IP addresses—192.168.0.1

- Subnet mask—255.255.255.0

These addresses are part of the IETF-designated private address range for use in private networks, and should be suitable in most applications. If your network has a requirement to use a different IP addressing scheme, you can make those changes in this menu.

The LAN IP parameters are:

- IP Address  
This is the LAN IP address of the router.
- IP Subnet Mask  
This is the LAN Subnet Mask of the router. Combined with the IP address, the IP Subnet Mask allows a device to know which other addresses are local to it, and which must be reached through a gateway or router.
- RIP Direction  
RIP (Router Information Protocol) allows a router to exchange routing information with other routers. The RIP Direction selection controls how the router sends and receives RIP packets. Both is the default.
  - When set to Both or Out Only, the router will broadcast its routing table periodically.
  - When set to Both or In Only, it will incorporate the RIP information that it receives.
  - When set to None, it will not send any RIP packets and will ignore any RIP packets received.
- RIP Version  
This controls the format and the broadcasting method of the RIP packets that the router sends. (It recognizes both formats when receiving.) By default, this is set for RIP-1.
  - RIP-1 is universally supported. RIP-1 is probably adequate for most networks, unless you have an unusual network setup.
  - RIP-2 carries more information. RIP-2B uses subnet broadcasting.



**Note:** If you change the LAN IP address of the router while connected through the browser, you will be disconnected. You may need to restart your computer for the new IP address setting to take effect.

## Using the Router as a DHCP server

By default, the router will function as a DHCP (Dynamic Host Configuration Protocol) server, allowing it to assign IP, DNS server, and default gateway addresses to all computers connected to the router's LAN. The assigned default gateway address is the LAN address of the router. IP addresses will be assigned to the attached PCs from a pool of addresses specified in this menu. Each pool address is tested before it is assigned to avoid duplicate addresses on the LAN.

For most applications, the default DHCP and TCP/IP settings of the router are satisfactory. See [“IP Configuration by DHCP”](#) on [page B-10](#) for an explanation of DHCP and information about how to assign IP addresses for your network.

If another device on your network will be the DHCP server, or if you will manually configure the network settings of all of your computers, clear the ‘Use router as DHCP server’ check box. Otherwise, leave it checked.

Specify the pool of IP addresses to be assigned by setting the Starting IP Address and Ending IP Address. These addresses should be part of the same IP address subnet as the router’s LAN IP address. Using the default addressing scheme, you should define a range between 192.168.0.2 and 192.168.0.253, although you may wish to save part of the range for devices with fixed addresses.

The router will deliver the following parameters to any LAN device that requests DHCP:

- An IP Address from the range you have defined
- Subnet Mask
- Gateway IP Address (the router’s LAN IP address)
- Primary DNS Server (if you entered a Primary DNS address in the Basic Settings menu; otherwise, the router’s LAN IP address)
- Secondary DNS Server (if you entered a Secondary DNS address in the Basic Settings menu)

## Using Address Reservation

When you specify a reserved IP address for a PC on the LAN, that PC will always receive the same IP address each time it access the router’s DHCP server. Reserved IP addresses should be assigned to servers that require permanent IP settings.

To reserve an IP address:

1. Click the Add button.

2. In the IP Address box, type the IP address to assign to the PC or server.  
(choose an IP address from the router's LAN subnet, such as 192.168.0.X)
3. Type the MAC Address of the PC or server.  
(Tip: If the PC is already present on your network, you can copy its MAC address from the Attached Devices menu and paste it here.)
4. Click Apply to enter the reserved address into the table.

Note: The reserved address will not be assigned until the next time the PC contacts the router's DHCP server. Reboot the PC or access its IP configuration and force a DHCP release and renew.

To edit or delete a reserved address entry:

1. Click the button next to the reserved address you want to edit or delete.
2. Click Edit or Delete.

## How to Configure Static Routes

---

Static Routes provide additional routing information to your router. Under normal circumstances, the router has adequate routing information after it has been configured for Internet access, and you do not need to configure additional static routes. You must configure static routes only for unusual cases such as multiple routers or multiple IP subnets located on your network.

From the Main Menu of the browser interface, under Advanced, click on Static Routes to view the Static Route menu, shown below.

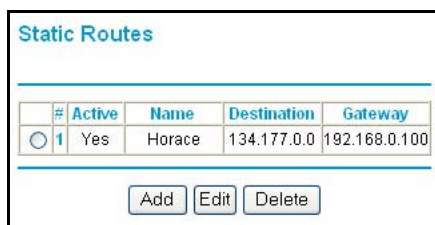

The screenshot shows a web interface titled "Static Routes". Below the title is a table with the following data:

#	Active	Name	Destination	Gateway
1	Yes	Horace	134.177.0.0	192.168.0.100

Below the table are three buttons: "Add", "Edit", and "Delete".

**Figure 6-4. Static Route Summary Table**

To add or edit a Static Route:



1. Click the Add button to open the Add/Edit Menu, shown below.

**Static Routes**

Route Name

Private

Active

Destination IP Address  .  .  .

IP Subnet Mask  .  .  .

Gateway IP Address  .  .  .

Metric

**Figure 6-5. Static Route Entry and Edit Menu**

2. Type a route name for this static route in the Route Name box under the table.  
(This is for identification purpose only.)
3. Select Private if you want to limit access to the LAN only. The static route will not be reported in RIP.
4. Select Active to make this route effective.
5. Type the Destination IP Address of the final destination.
6. Type the IP Subnet Mask for this destination.  
If the destination is a single host, type 255.255.255.255.
7. Type the Gateway IP Address, which must be a router on the same LAN segment as the router.
8. Type a number between 1 and 15 as the Metric value.  
This represents the number of routers between your network and the destination. Usually, a setting of 2 or 3 works, but if this is a direct connection, set it to 1.
9. Click Apply to have the static route entered into the table.

As an example of when a static route is needed, consider the following case:

- Your primary Internet access is through a cable modem to an ISP.
- You have an ISDN router on your home network for connecting to the company where you are employed. This router's address on your LAN is 192.168.0.100.
- Your company's network is 134.177.0.0.

When you first configured your router, two implicit static routes were created. A default route was created with your ISP as the gateway, and a second static route was created to your local network for all 192.168.0.x addresses. With this configuration, if you attempt to access a device on the 134.177.0.0 network, your router will forward your request to the ISP. The ISP forwards your request to the company where you are employed, and the request will likely be denied by the company's firewall.

In this case you must define a static route, telling your router that 134.177.0.0 should be accessed through the ISDN router at 192.168.0.100. The static route would look like [Figure 6-5](#).

In this example:

- The Destination IP Address and IP Subnet Mask fields specify that this static route applies to all 134.177.0.x addresses.
- The Gateway IP Address fields specifies that all traffic for these addresses should be forwarded to the ISDN router at 192.168.0.100.
- A Metric value of 1 will work since the ISDN router is on the LAN.
- Private is selected only as a precautionary security measure in case RIP is activated.

## Enabling Remote Management Access

---

Using the Remote Management page, you can allow a user or users on the Internet to configure, upgrade and check the status of your WGR614 router.

	<p><b>Note:</b> Be sure to change the router's default configuration password to a very secure password. The ideal password should contain no dictionary words from any language, and should be a mixture of letters (both upper and lower case), numbers, and symbols. Your password can be up to 30 characters.</p>
---	---

To configure your router for Remote Management:

1. Select the Turn Remote Management On check box.
2. Specify what external addresses will be allowed to access the router's remote management.

**Note:** For enhanced security, restrict access to as few external IP addresses as practical.

- a. To allow access from any IP address on the Internet, select Everyone.

- b. To allow access from a range of IP addresses on the Internet, select IP address range. Enter a beginning and ending IP address to define the allowed range.
  - c. To allow access from a single IP address on the Internet, select Only this PC. Enter the IP address that will be allowed access.
3. Specify the Port Number that will be used for accessing the management interface.  
Web browser access normally uses the standard HTTP service port 80. For greater security, you can change the remote management web interface to a custom port by entering that number in the box provided. Choose a number between 1024 and 65535, but do not use the number of any common service port. The default is 8080, which is a common alternate for HTTP.
  4. Click Apply to have your changes take effect.

**Note:** When accessing your router from the Internet, you will type your router's WAN IP address into your browser's Address (in IE) or Location (in Netscape) box, followed by a colon (:) and the custom port number. For example, if your external address is 134.177.0.123 and you use port number 8080, you must enter `http://134.177.0.123:8080` in your browser.

## Using Universal Plug and Play (UPnP)

Universal Plug and Play (UPnP) helps devices, such as Internet appliances and computers, access the network and connect to other devices as needed. UPnP devices can automatically discover the services from other registered UPnP devices on the network.

UPnP

Turn UPnP On

Advertisement Period (in minutes)

Advertisement Time To Live (in hops)

UPnP Portmap Table

Active	Protocol	Int. Port	Ext. Port	IP Address
Yes	TCP	9198	11913	192.168.0.2
Yes	UDP	5339	7102	192.168.0.2

**Figure 6-6.** UPnP Menu

**Turn UPnP On:** UPnP can be enabled or disabled for automatic device configuration. The default setting for UPnP is enabled. If disabled, the router will not allow any device to automatically control the resources, such as port forwarding (mapping), of the router.

**Advertisement Period:** The Advertisement Period is how often the router will broadcast its UPnP information. This value can range from 1 to 1440 minutes. The default period is 30 minutes. Shorter durations will ensure that control points have current device status at the expense of additional network traffic. Longer durations may compromise the freshness of the device status but can significantly reduce network traffic.

**Advertisement Time To Live:** The time to live for the advertisement is measured in hops (steps) for each UPnP packet sent. The time to live hop count is the number of steps a broadcast packet is allowed to propagate for each UPnP advertisement before it disappears. The number of hops can range from 1 to 255. The default value for the advertisement time to live is 4 hops, which should be fine for most home networks. If you notice that some devices are not being updated or reached correctly, then it may be necessary to increase this value a little.

**UPnP Portmap Table:** The UPnP Portmap Table displays the IP address of each UPnP device that is currently accessing the router and which ports (Internal and External) that device has opened. The UPnP Portmap Table also displays what type of port is opened and if that port is still active for each IP address.

---

# Chapter 7

## Troubleshooting

This chapter gives information about troubleshooting your Model WGR614 Cable/DSL Wireless Router. After each problem description, instructions are provided to help you diagnose and solve the problem.

### Basic Functioning

---

After you turn on power to the router, the following sequence of events should occur:

1. When power is first applied, verify that the Power LED  is on.
2. After approximately 10 seconds, verify that:
  - a. The Test LED is not lit.
  - b. The LAN port LEDs are lit for any local ports that are connected.
  - c. The WAN port LED is lit.

If a port's LED is lit, a link has been established to the connected device. If a LAN port is connected to a 100 Mbps device, verify that the port's LED is green. If the port is 10 Mbps, the LED will be amber.

If any of these conditions does not occur, refer to the appropriate following section.

### Power LED Not On

If the Power and other LEDs are off when your router is turned on:

- Make sure that the power cord is properly connected to your router and that the power supply adapter is properly connected to a functioning power outlet.

- Check that you are using the 12 V DC 800mA power adapter supplied by NETGEAR for this product.

If the error persists, you have a hardware problem and should contact technical support.

## **LEDs Never Turn Off**

When the router is turned on, the LEDs turn on for about 10 seconds and then turn off. If all the LEDs stay on, there is a fault within the router.

If all LEDs are still on one minute after power up:

- Cycle the power to see if the router recovers.
- Clear the router's configuration to factory defaults. This will set the router's IP address to 192.168.0.1. This procedure is explained in [“Restoring the Default Configuration and Password” on page 7-7](#).

If the error persists, you might have a hardware problem and should contact technical support.

## **LAN or WAN Port LEDs Not On**

If either the LAN LEDs or WAN LED do not light when the Ethernet connection is made, check the following:

- Make sure that the Ethernet cable connections are secure at the router and at the hub or workstation.
- Make sure that power is turned on to the connected hub or workstation.
- Be sure you are using the correct cable:
  - When connecting the router's WAN port to a cable or DSL modem, use the cable that was supplied with the cable or DSL modem. This cable could be a standard straight-through Ethernet cable or an Ethernet crossover cable.

## Troubleshooting the Web Configuration Interface

---

If you are unable to access the router's Web Configuration interface from a PC on your local network, check the following:

- Check the Ethernet connection between the PC and the router as described in the previous section.
- Make sure your PC's IP address is on the same subnet as the router. If you are using the recommended addressing scheme, your PC's address should be in the range of 192.168.0.2 to 192.168.0.254. Refer to [“Verifying TCP/IP Properties” on page C-6](#) or [“Verifying TCP/IP Properties for Macintosh Computers” on page C-17](#) to find your PC's IP address. Follow the instructions in [Appendix C](#) to configure your PC.

**Note:** If your PC's IP address is shown as 169.254.x.x: Recent versions of Windows and MacOS will generate and assign an IP address if the computer cannot reach a DHCP server. These auto-generated addresses are in the range of 169.254.x.x. If your IP address is in this range, check the connection from the PC to the router and reboot your PC.

- If your router's IP address has been changed and you don't know the current IP address, clear the router's configuration to factory defaults. This will set the router's IP address to 192.168.0.1. This procedure is explained in [“Restoring the Default Configuration and Password” on page 7-7](#).
- Make sure your browser has Java, JavaScript, or ActiveX enabled. If you are using Internet Explorer, click Refresh to be sure the Java applet is loaded.
- Try quitting the browser and launching it again.
- Make sure you are using the correct login information. The factory default login name is **admin** and the password is **password**. Make sure that CAPS LOCK is off when entering this information.

If the router does not save changes you have made in the Web Configuration Interface, check the following:

- When entering configuration settings, be sure to click the APPLY button before moving to another menu or tab, or your changes are lost.
- Click the Refresh or Reload button in the Web browser. The changes may have occurred, but the Web browser may be caching the old configuration.

## Troubleshooting the ISP Connection

---

If your router is unable to access the Internet, you should first determine whether the router is able to obtain a WAN IP address from the ISP. Unless you have been assigned a static IP address, your router must request an IP address from the ISP. You can determine whether the request was successful using the Web Configuration Manager.

To check the WAN IP address:

1. Launch your browser and select an external site such as [www.netgear.com](http://www.netgear.com)
2. Access the Main Menu of the router's configuration at <http://192.168.0.1>
3. Under the Maintenance heading, select Router Status
4. Check that an IP address is shown for the WAN Port  
If 0.0.0.0 is shown, your router has not obtained an IP address from your ISP.

If your router is unable to obtain an IP address from the ISP, you may need to force your cable or DSL modem to recognize your new router by performing the following procedure:

1. Turn off power to the cable or DSL modem.
2. Turn off power to your router.
3. Wait five minutes and reapply power to the cable or DSL modem.
4. When the modem's LEDs indicate that it has reacquired sync with the ISP, reapply power to your router.

If your router is still unable to obtain an IP address from the ISP, the problem may be one of the following:

- Your ISP may require a login program.  
Ask your ISP whether they require PPP over Ethernet (PPPoE) or some other type of login.
- If your ISP requires a login, you may have incorrectly set the login name and password.
- Your ISP may check for your PC's host name.  
Assign the PC Host Name of your ISP account as the Account Name in the Basic Settings menu.
- Your ISP only allows one Ethernet MAC address to connect to Internet, and may check for your PC's MAC address. In this case:  
  
Inform your ISP that you have bought a new network device, and ask them to use the router's MAC address.



OR

Configure your router to spoof your PC's MAC address. This can be done in the Basic Settings menu. Refer to [“How to Manually Configure Your Internet Connection”](#) on page 2-12.

If your router can obtain an IP address, but your PC is unable to load any web pages from the Internet:

- Your PC may not recognize any DNS server addresses.

A DNS server is a host on the Internet that translates Internet names (such as www addresses) to numeric IP addresses. Typically your ISP will provide the addresses of one or two DNS servers for your use. If you entered a DNS address during the router's configuration, reboot your PC and verify the DNS address as described in [“Verifying TCP/IP Properties”](#) on page C-6. Alternatively, you may configure your PC manually with DNS addresses, as explained in your operating system documentation.

- Your PC may not have the router configured as its TCP/IP gateway.

If your PC obtains its information from the router by DHCP, reboot the PC and verify the gateway address as described in [“Verifying TCP/IP Properties”](#) on page C-6.

## Troubleshooting a TCP/IP Network Using a Ping Utility

---

Most TCP/IP terminal devices and routers contain a ping utility that sends an echo request packet to the designated device. The device then responds with an echo reply. Troubleshooting a TCP/IP network is made very easy by using the ping utility in your PC or workstation.

### Testing the LAN Path to Your Router

You can ping the router from your PC to verify that the LAN path to your router is set up correctly.

To ping the router from a PC running Windows 95 or later:

1. From the Windows toolbar, click on the Start button and select Run.
2. In the field provided, type Ping followed by the IP address of the router, as in this example:

```
ping 192.168.0.1
```

3. Click on OK.

You should see a message like this one:

```
Pinging <IP address> with 32 bytes of data
```

If the path is working, you see this message:

```
Reply from < IP address >: bytes=32 time=NN ms TTL=xxx
```

If the path is not working, you see this message:

```
Request timed out
```

If the path is not functioning correctly, you could have one of the following problems:

- Wrong physical connections
  - Make sure the LAN port LED is on. If the LED is off, follow the instructions in [“LAN or WAN Port LEDs Not On”](#) on page 7-2.
  - Check that the corresponding Link LEDs are on for your network interface card and for the hub ports (if any) that are connected to your workstation and router.
- Wrong network configuration
  - Verify that the Ethernet card driver software and TCP/IP software are both installed and configured on your PC or workstation.
  - Verify that the IP address for your router and your workstation are correct and that the addresses are on the same subnet.

## Testing the Path from Your PC to a Remote Device

After verifying that the LAN path works correctly, test the path from your PC to a remote device. From the Windows run menu, type:

```
PING -n 10 <IP address>
```

where *<IP address>* is the IP address of a remote device such as your ISP's DNS server.

If the path is functioning correctly, replies as in the previous section are displayed. If you do not receive replies:

- Check that your PC has the IP address of your router listed as the default gateway. If the IP configuration of your PC is assigned by DHCP, this information will not be visible in your PC's Network Control Panel. Verify that the IP address of the router is listed as the default gateway as described in [“Verifying TCP/IP Properties”](#) on page C-6.
- Check to see that the network address of your PC (the portion of the IP address specified by the netmask) is different from the network address of the remote device.
- Check that your cable or DSL modem is connected and functioning.

- If your ISP assigned a host name to your PC, enter that host name as the Account Name in the Basic Settings menu.
- Your ISP could be rejecting the Ethernet MAC addresses of all but one of your PCs. Many broadband ISPs restrict access by only allowing traffic from the MAC address of your broadband modem, but some ISPs additionally restrict access to the MAC address of a single PC connected to that modem. If this is the case, you must configure your router to “clone” or “spoof” the MAC address from the authorized PC. Refer to [“How to Manually Configure Your Internet Connection”](#) on page 2-12.

## Restoring the Default Configuration and Password

---

This section explains how to restore the factory default configuration settings, changing the router’s administration password to **password** and the IP address to 192.168.0.1. You can erase the current configuration and restore factory defaults in two ways:

- Use the Erase function of the router (see [“Erasing the Configuration”](#) on page 5-8).
- Use the Default Reset button on the rear panel of the router. Use this method for cases when the administration password or IP address is not known.

To restore the factory default configuration settings without knowing the administration password or IP address, you must use the Default Reset button on the rear panel of the router.

1. Press and hold the Default Reset button until the Test LED turns on (about 10 seconds).
2. Release the Default Reset button and wait for the router to reboot.

## Problems with Date and Time

---

The E-Mail menu in the Content Filtering section displays the current date and time of day. The WGR614 router uses the Network Time Protocol (NTP) to obtain the current time from one of several Network Time Servers on the Internet. Each entry in the log is stamped with the date and time of day. Problems with the date and time function can include:

- Date shown is January 1, 2000. Cause: The router has not yet successfully reached a Network Time Server. Check that your Internet access settings are configured correctly. If you have just completed configuring the router, wait at least five minutes and check the date and time again.
- Time is off by one hour. Cause: The router does not automatically sense Daylight Savings Time. In the E-Mail menu, check or uncheck the box marked “Adjust for Daylight Savings Time”.

This page intentionally left blank.

# Appendix A

## Technical Specifications

This appendix provides technical specifications for the Model WGR614 Cable/DSL Wireless Router.

### Network Protocol and Standards Compatibility

Data and Routing Protocols: TCP/IP, RIP-1, RIP-2, DHCP  
PPP over Ethernet (PPPoE)

### Power Adapter

North America: 120V, 60 Hz, input  
United Kingdom, Australia: 240V, 50 Hz, input  
Europe: 230V, 50 Hz, input  
Japan: 100V, 50/60 Hz, input  
All regions (output): 12 V DC @ 800 mA output, 22W maximum

### Physical Specifications

Dimensions: 28 x 175 x 118 mm (1.1 x 6.89 x 4.65 in.)  
Weight: 0.3 kg (0.66 lb)

---

**Environmental Specifications**

Operating temperature: 0° to 40° C (32° to 104° F)  
Operating humidity: 90% maximum relative humidity, noncondensing

**Electromagnetic Emissions**

Meets requirements of: FCC Part 15 Class B  
VCCI Class B  
EN 55 022 (CISPR 22), Class B

**Interface Specifications**

LAN: 10BASE-T or 100BASE-Tx, RJ-45  
WAN: 10BASE-T, RJ-45

**Wireless**

Radio Data Rates 1, 2, 5.5, 6, 9, 12, 18, 24, 36, 48, and 54 Mbps  
Auto Rate Sensing  
Frequency 2.4-2.5Ghz  
Data Encoding: Direct Sequence Spread Spectrum (DSSS)  
Maximum Computers Per Wireless Network: Limited by the amount of wireless network traffic generated by each node. Typically 30-70 nodes.  
Operating Frequency Ranges: 2.412~2.462 GHz (US) 2.457~2.462 GHz (Spain)  
2.412~2.484 GHz (Japan) 2.457~2.472 GHz (France)  
2.412~2.472 GHz (Europe ETSI)  
Encryption: 40-bits (also called 64-bits), 128-bits WEP data encryption

---

# Appendix B

## Network, Routing, Firewall, and Basics

This chapter provides an overview of IP networks, routing, and networking.

### Related Publications

---

As you read this document, you may be directed to various RFC documents for further information. An RFC is a Request For Comment (RFC) published by the Internet Engineering Task Force (IETF), an open organization that defines the architecture and operation of the Internet. The RFC documents outline and define the standard protocols and procedures for the Internet. The documents are listed on the World Wide Web at [www.ietf.org](http://www.ietf.org) and are mirrored and indexed at many other sites worldwide.

### Basic Router Concepts

---

Large amounts of bandwidth can be provided easily and relatively inexpensively in a local area network (LAN). However, providing high bandwidth between a local network and the Internet can be very expensive. Because of this expense, Internet access is usually provided by a slower-speed wide-area network (WAN) link such as a cable or DSL modem. In order to make the best use of the slower WAN link, a mechanism must be in place for selecting and transmitting only the data traffic meant for the Internet. The function of selecting and forwarding this data is performed by a router.

## What is a Router?

A router is a device that forwards traffic between networks based on network layer information in the data and on routing tables maintained by the router. In these routing tables, a router builds up a logical picture of the overall network by gathering and exchanging information with other routers in the network. Using this information, the router chooses the best path for forwarding network traffic.

Routers vary in performance and scale, number of routing protocols supported, and types of physical WAN connection they support. The Model WGR614 Cable/DSL Wireless Router is a small office router that routes the IP protocol over a single-user broadband connection.

## Routing Information Protocol

One of the protocols used by a router to build and maintain a picture of the network is the Routing Information Protocol (RIP). Using RIP, routers periodically update one another and check for changes to add to the routing table.

The WGR614 router supports both the older RIP-1 and the newer RIP-2 protocols. Among other improvements, RIP-2 supports subnet and multicast protocols. RIP is not required for most home applications.

## IP Addresses and the Internet

---

Because TCP/IP networks are interconnected across the world, every machine on the Internet must have a unique address to make sure that transmitted data reaches the correct destination. Blocks of addresses are assigned to organizations by the Internet Assigned Numbers Authority (IANA). Individual users and small organizations may obtain their addresses either from the IANA or from an Internet service provider (ISP). You can contact IANA at [www.iana.org](http://www.iana.org).

The Internet Protocol (IP) uses a 32-bit address structure. The address is usually written in dot notation (also called dotted-decimal notation), in which each group of eight bits is written in decimal form, separated by decimal points.

For example, the following binary address:

```
11000011 00100010 00001100 00000111
```

is normally written as:

```
195.34.12.7
```



The latter version is easier to remember and easier to enter into your computer.

In addition, the 32 bits of the address are subdivided into two parts. The first part of the address identifies the network, and the second part identifies the host node or station on the network. The dividing point may vary depending on the address range and the application.

There are five standard classes of IP addresses. These address classes have different ways of determining the network and host sections of the address, allowing for different numbers of hosts on a network. Each address type begins with a unique bit pattern, which is used by the TCP/IP software to identify the address class. After the address class has been determined, the software can correctly identify the host section of the address. The follow figure shows the three main address classes, including network and host sections of the address for each address type.

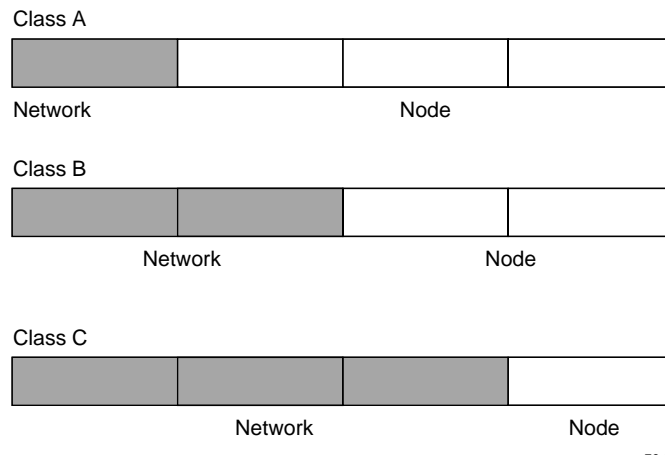

**Figure 7-1: Three Main Address Classes**

The five address classes are:

- **Class A**  
Class A addresses can have up to 16,777,214 hosts on a single network. They use an eight-bit network number and a 24-bit node number. Class A addresses are in this range:  
1.x.x.x to 126.x.x.x.
- **Class B**  
Class B addresses can have up to 65,354 hosts on a network. A Class B address uses a 16-bit network number and a 16-bit node number. Class B addresses are in this range:  
128.1.x.x to 191.254.x.x.

- Class C  
Class C addresses can have 254 hosts on a network. Class C addresses use 24 bits for the network address and eight bits for the node. They are in this range:  
192.0.1.x to 223.255.254.x.
- Class D  
Class D addresses are used for multicasts (messages sent to many hosts). Class D addresses are in this range:  
224.0.0.0 to 239.255.255.255.
- Class E  
Class E addresses are for experimental use.

This addressing structure allows IP addresses to uniquely identify each physical network and each node on each physical network.

For each unique value of the network portion of the address, the base address of the range (host address of all zeros) is known as the network address and is not usually assigned to a host. Also, the top address of the range (host address of all ones) is not assigned, but is used as the broadcast address for simultaneously sending a packet to all hosts with the same network address.

## Netmask

In each of the address classes previously described, the size of the two parts (network address and host address) is implied by the class. This partitioning scheme can also be expressed by a netmask associated with the IP address. A netmask is a 32-bit quantity that, when logically combined (using an AND operator) with an IP address, yields the network address. For instance, the netmasks for Class A, B, and C addresses are 255.0.0.0, 255.255.0.0, and 255.255.255.0, respectively.

For example, the address 192.168.170.237 is a Class C IP address whose network portion is the upper 24 bits. When combined (using an AND operator) with the Class C netmask, as shown here, only the network portion of the address remains:

```
11000000 10101000 10101010 11101101 (192.168.170.237)
```

combined with:

```
11111111 11111111 11111111 00000000 (255.255.255.0)
```

Equals:

```
11000000 10101000 10101010 00000000 (192.168.170.0)
```

As a shorter alternative to dotted-decimal notation, the netmask may also be expressed in terms of the number of ones from the left. This number is appended to the IP address, following a backward slash (/), as “/n.” In the example, the address could be written as 192.168.170.237/24, indicating that the netmask is 24 ones followed by 8 zeros.

## Subnet Addressing

By looking at the addressing structures, you can see that even with a Class C address, there are a large number of hosts per network. Such a structure is an inefficient use of addresses if each end of a routed link requires a different network number. It is unlikely that the smaller office LANs would have that many devices. You can resolve this problem by using a technique known as subnet addressing.

Subnet addressing allows us to split one IP network address into smaller multiple physical networks known as subnetworks. Some of the node numbers are used as a subnet number instead. A Class B address gives us 16 bits of node numbers translating to 64,000 nodes. Most organizations do not use 64,000 nodes, so there are free bits that can be reassigned. Subnet addressing makes use of those bits that are free, as shown below.



**Figure 7-2: Example of Subnetting a Class B Address**

A Class B address can be effectively translated into multiple Class C addresses. For example, the IP address of 172.16.0.0 is assigned, but node addresses are limited to 255 maximum, allowing eight extra bits to use as a subnet address. The IP address of 172.16.97.235 would be interpreted as IP network address 172.16, subnet number 97, and node number 235. In addition to extending the number of addresses available, subnet addressing provides other benefits. Subnet addressing allows a network manager to construct an address scheme for the network by using different subnets for other geographical locations in the network or for other departments in the organization.

Although the preceding example uses the entire third octet for a subnet address, note that you are not restricted to octet boundaries in subnetting. To create more network numbers, you need only shift some bits from the host address to the network address. For instance, to partition a Class C network number (192.68.135.0) into two, you shift one bit from the host address to the network address. The new netmask (or subnet mask) is 255.255.255.128. The first subnet has network number 192.68.135.0 with hosts 192.68.135.1 to 192.68.135.126, and the second subnet has network number 192.68.135.128 with hosts 192.68.135.129 to 192.68.135.254.



**Note:** The number 192.68.135.127 is not assigned because it is the broadcast address of the first subnet. The number 192.68.135.128 is not assigned because it is the network address of the second subnet.

The following table lists the additional subnet mask bits in dotted-decimal notation. To use the table, write down the original class netmask and replace the 0 value octets with the dotted-decimal value of the additional subnet bits. For example, to partition your Class C network with subnet mask 255.255.255.0 into 16 subnets (4 bits), the new subnet mask becomes 255.255.255.240.

**Table 8. Netmask Notation Translation Table for One Octet**

Number of Bits	Dotted-Decimal Value
1	128
2	192
3	224
4	240
5	248
6	252
7	254
8	255

The following table displays several common netmask values in both the dotted-decimal and the masklength formats.

**Table 9. Netmask Formats**

Dotted-Decimal	Masklength
255.0.0.0	/8
255.255.0.0	/16

**Table 9. Netmask Formats**

255.255.255.0	/24
255.255.255.128	/25
255.255.255.192	/26
255.255.255.224	/27
255.255.255.240	/28
255.255.255.248	/29
255.255.255.252	/30
255.255.255.254	/31
255.255.255.255	/32

Configure all hosts on a LAN segment to use the same netmask for the following reasons:

- So that hosts recognize local IP broadcast packets  
When a device broadcasts to its segment neighbors, it uses a destination address of the local network address with all ones for the host address. In order for this scheme to work, all devices on the segment must agree on which bits comprise the host address.
- So that a local router or bridge recognizes which addresses are local and which are remote

## Private IP Addresses

If your local network is isolated from the Internet (for example, when using NAT), you can assign any IP addresses to the hosts without problems. However, the IANA has reserved the following three blocks of IP addresses specifically for private networks:

10.0.0.0 - 10.255.255.255  
172.16.0.0 - 172.31.255.255  
192.168.0.0 - 192.168.255.255

Choose your private network number from this range. The DHCP server of the WGR614 router is preconfigured to automatically assign private addresses.

Regardless of your particular situation, do not create an arbitrary IP address; always follow the guidelines explained here. For more information about address assignment, refer to RFC 1597, *Address Allocation for Private Internets*, and RFC 1466, *Guidelines for Management of IP Address Space*. [The Internet Engineering Task Force \(IETF\)](http://www.ietf.org) publishes RFCs on its Web site at [www.ietf.org](http://www.ietf.org).

## Single IP Address Operation Using NAT

---

In the past, if multiple PCs on a LAN needed to access the Internet simultaneously, you had to obtain a range of IP addresses from the ISP. This type of Internet account is more costly than a single-address account typically used by a single user with a modem, rather than a router. The WGR614 router employs an address-sharing method called Network Address Translation (NAT). This method allows several networked PCs to share an Internet account using only a single IP address, which may be statically or dynamically assigned by your ISP.

The router accomplishes this address sharing by translating the internal LAN IP addresses to a single address that is globally unique on the Internet. The internal LAN IP addresses can be either private addresses or registered addresses. For more information about IP address translation, refer to RFC 1631, *The IP Network Address Translator (NAT)*.

The following figure illustrates a single IP address operation.

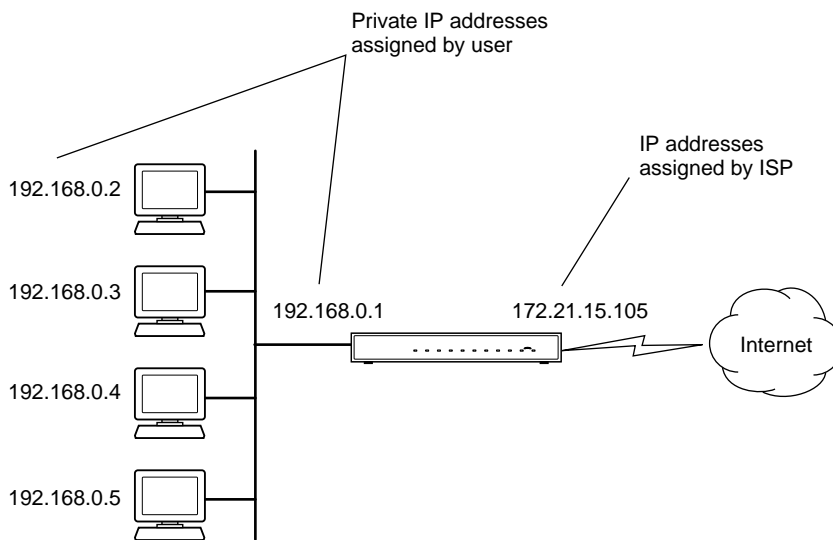

**Figure 9-1: Single IP Address Operation Using NAT**

This scheme offers the additional benefit of firewall-like protection because the internal LAN addresses are not available to the Internet through the translated connection. All incoming inquiries are filtered out by the router. This filtering can prevent intruders from probing your system. However, using port forwarding, you can allow one PC (for example, a Web server) on your local network to be accessible to outside users.

## MAC Addresses and Address Resolution Protocol

An IP address alone cannot be used to deliver data from one LAN device to another. To send data between LAN devices, you must convert the IP address of the destination device to its media access control (MAC) address. Each device on an Ethernet network has a unique MAC address, which is a 48-bit number assigned to each device by the manufacturer. The technique that associates the IP address with a MAC address is known as address resolution. Internet Protocol uses the Address Resolution Protocol (ARP) to resolve MAC addresses.

If a device sends data to another station on the network and the destination MAC address is not yet recorded, ARP is used. An ARP request is broadcast onto the network. All stations on the network receive and read the request. The destination IP address for the chosen station is included as part of the message so that only the station with this IP address responds to the ARP request. All other stations discard the request.

## Related Documents

The station with the correct IP address responds with its own MAC address directly to the sending device. The receiving station provides the transmitting station with the required destination MAC address. The IP address data and MAC address data for each station are held in an ARP table. The next time data is sent, the address can be obtained from the address information in the table.

For more information about address assignment, refer to the IETF documents RFC 1597, *Address Allocation for Private Internets*, and RFC 1466, *Guidelines for Management of IP Address Space*.

For more information about IP address translation, refer to RFC 1631, *The IP Network Address Translator (NAT)*.

## Domain Name Server

Many of the resources on the Internet can be addressed by simple descriptive names such as *www.NETGEAR.com*. This addressing is very helpful at the application level, but the descriptive name must be translated to an IP address in order for a user to actually contact the resource. Just as a telephone directory maps names to phone numbers, or as an ARP table maps IP addresses to MAC addresses, a domain name system (DNS) server maps descriptive names of network resources to IP addresses.

When a PC accesses a resource by its descriptive name, it first contacts a DNS server to obtain the IP address of the resource. The PC sends the desired message using the IP address. Many large organizations, such as ISPs, maintain their own DNS servers and allow their customers to use the servers to look up addresses.

## IP Configuration by DHCP

---

When an IP-based local area network is installed, each PC must be configured with an IP address. If the PCs need to access the Internet, they should also be configured with a gateway address and one or more DNS server addresses. As an alternative to manual configuration, there is a method by which each PC on the network can automatically obtain this configuration information. A device on the network may act as a Dynamic Host Configuration Protocol (DHCP) server. The DHCP server stores a list or pool of IP addresses, along with other information (such as gateway and DNS addresses) that it may assign to the other devices on the network. The WGR614 router has the capacity to act as a DHCP server.

The WGR614 router also functions as a DHCP client when connecting to the ISP. The firewall can automatically obtain an IP address, subnet mask, DNS server addresses, and a gateway address if the ISP provides this information by DHCP.

## Internet Security and Firewalls

---

When your LAN connects to the Internet through a router, an opportunity is created for outsiders to access or disrupt your network. A NAT router provides some protection because by the very nature of the process, the network behind the router is shielded from access by outsiders on the Internet. However, there are methods by which a determined hacker can possibly obtain information about your network or at the least can disrupt your Internet access. A greater degree of protection is provided by a firewall router.



## What is a Firewall?

A firewall is a device that protects one network from another, while allowing communication between the two. A firewall incorporates the functions of the NAT router, while adding features for dealing with a hacker intrusion or attack. Several known types of intrusion or attack can be recognized when they occur. When an incident is detected, the firewall can log details of the attempt, and can optionally send email to an administrator notifying them of the incident. Using information from the log, the administrator can take action with the ISP of the hacker. In some types of intrusions, the firewall can fend off the hacker by discarding all further packets from the hacker's IP address for a period of time.

### Stateful Packet Inspection

Unlike simple Internet sharing routers, a firewall uses a process called stateful packet inspection to ensure secure firewall filtering to protect your network from attacks and intrusions. Since user-level applications such as FTP and Web browsers can create complex patterns of network traffic, it is necessary for the firewall to analyze groups of network connection states. Using Stateful Packet Inspection, an incoming packet is intercepted at the network layer and then analyzed for state-related information associated with all network connections. A central cache within the firewall keeps track of the state information associated with all network connections. All traffic passing through the firewall is analyzed against the state of these connections in order to determine whether or not it will be allowed to pass through or rejected.

### Denial of Service Attack

A hacker may be able to prevent your network from operating or communicating by launching a Denial of Service (DoS) attack. The method used for such an attack can be as simple as merely flooding your site with more requests than it can handle. A more sophisticated attack may attempt to exploit some weakness in the operating system used by your router or gateway. Some operating systems can be disrupted by simply sending a packet with incorrect length information.

## Ethernet Cabling

---

Although Ethernet networks originally used thick or thin coaxial cable, most installations currently use unshielded twisted pair (UTP) cabling. The UTP cable contains eight conductors, arranged in four twisted pairs, and terminated with an RJ45 type connector. A normal straight-through UTP Ethernet cable follows the EIA568B standard wiring and pinout as described in [Table 10](#).

**Table 10. UTP Ethernet cable wiring, straight-through**

Pin	Wire color	Signal
1	Orange/White	Transmit (Tx) +
2	Orange	Transmit (Tx) -
3	Green/White	Receive (Rx) +
4	Blue	
5	Blue/White	
6	Green	Receive (Rx) -
7	Brown/White	
8	Brown	

## Uplink Switches, Crossover Cables, and MDI/MDIX Switching

In the wiring table above, the concept of transmit and receive are from the perspective of the PC, which is wired as Media Dependant Interface (MDI). In this wiring, the PC transmits on pins 1 and 2. At the hub, the perspective is reversed, and the hub receives on pins 1 and 2. This wiring is referred to as Media Dependant Interface - Crossover (MDI-X).

When connecting a PC to a PC, or a hub port to another hub port, the transmit pair must be exchanged with the receive pair. This exchange is done by one of two mechanisms. Most hubs provide an Uplink switch which will exchange the pairs on one port, allowing that port to be connected to another hub using a normal Ethernet cable. The second method is to use a crossover cable, which is a special cable in which the transmit and receive pairs are exchanged at one of the two cable connectors. Crossover cables are often unmarked as such, and must be identified by comparing the two connectors. Since the cable connectors are clear plastic, it is easy to place them side by side and view the order of the wire colors on each. On a straight-through cable, the color order will be the same on both connectors. On a crossover cable, the orange and blue pairs will be exchanged from one connector to the other.

The WGR614 router incorporates Auto Uplink™ technology (also called MDI/MDIX). Each LOCAL Ethernet port will automatically sense whether the Ethernet cable plugged into the port should have a normal connection (e.g. connecting to a PC) or an uplink connection (e.g. connecting to a router, switch, or hub). That port will then configure itself to the correct configuration. This feature also eliminates the need to worry about crossover cables, as Auto Uplink™ will accommodate either type of cable to make the right connection.

## **Cable Quality**

A twisted pair Ethernet network operating at 10 Mbits/second (10BASE-T) will often tolerate low quality cables, but at 100 Mbits/second (10BASE-Tx) the cable must be rated as Category 5, or Cat 5 or Cat V, by the Electronic Industry Association (EIA). This rating will be printed on the cable jacket. A Category 5 cable will meet specified requirements regarding loss and crosstalk. In addition, there are restrictions on maximum cable length for both 10 and 100 Mbits/second networks.

This page intentionally left blank.

# Appendix C

## Preparing Your Network

This appendix describes how to prepare your network to connect to the Internet through the Model WGR614 Cable/DSL Wireless Router and how to verify the readiness of broadband Internet service from an Internet service provider (ISP).



**Note:** If an ISP technician configured your computer during the installation of a broadband modem, or if you configured it using instructions provided by your ISP, you may need to copy the current configuration information for use in the configuration of your firewall. Write down this information before reconfiguring your computers. Refer to [“Obtaining ISP Configuration Information for Windows Computers”](#) on [page C-19](#) or [“Obtaining ISP Configuration Information for Macintosh Computers”](#) on [page C-20](#) for further information.

### Preparing Your Computers for TCP/IP Networking

---

Computers access the Internet using a protocol called TCP/IP (Transmission Control Protocol/Internet Protocol). Each computer on your network must have TCP/IP installed and selected as its networking protocol. If a Network Interface Card (NIC) is already installed in your PC, then TCP/IP is probably already installed as well.

Most operating systems include the software components you need for networking with TCP/IP:

- Windows® 95 or later includes the software components for establishing a TCP/IP network.
- Windows 3.1 does not include a TCP/IP component. You need to purchase a third-party TCP/IP application package such as NetManage Chameleon.
- Macintosh Operating System 7 or later includes the software components for establishing a TCP/IP network.

- All versions of UNIX or Linux include TCP/IP components. Follow the instructions provided with your operating system or networking software to install TCP/IP on your computer.

In your IP network, each PC and the firewall must be assigned a unique IP addresses. Each PC must also have certain other IP configuration information such as a subnet mask (netmask), a domain name server (DNS) address, and a default gateway address. In most cases, you should install TCP/IP so that the PC obtains its specific network configuration information automatically from a DHCP server during bootup. For a detailed explanation of the meaning and purpose of these configuration items, refer to “[Appendix B, “Network, Routing, Firewall, and Basics.”](#)”

The WGR614 router is shipped preconfigured as a DHCP server. The firewall assigns the following TCP/IP configuration information automatically when the PCs are rebooted:

- PC or workstation IP addresses—192.168.0.2 through 192.168.0.254
- Subnet mask—255.255.255.0
- Gateway address (the firewall)—192.168.0.1

These addresses are part of the IETF-designated private address range for use in private networks.

## **Configuring Windows 95, 98, and Me for TCP/IP Networking**

---

As part of the PC preparation process, you need to manually install and configure TCP/IP on each networked PC. Before starting, locate your Windows CD; you may need to insert it during the TCP/IP installation process.

### **Install or Verify Windows Networking Components**

To install or verify the necessary components for IP networking:

1. On the Windows taskbar, click the Start button, point to Settings, and then click Control Panel.
2. Double-click the Network icon.

The Network window opens, which displays a list of installed components:

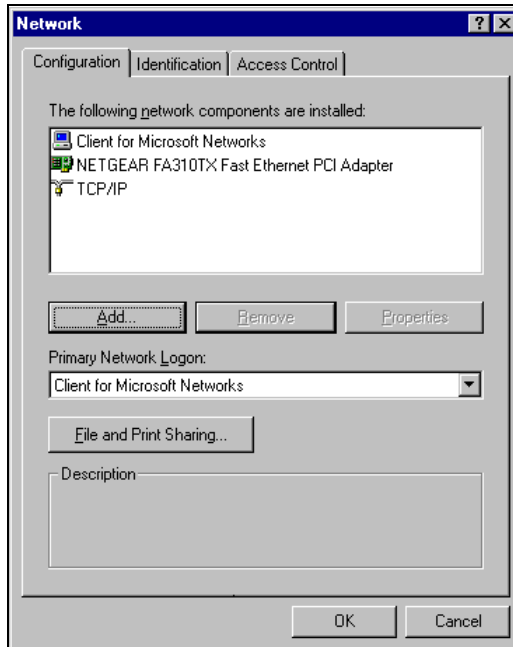

You must have an Ethernet adapter, the TCP/IP protocol, and Client for Microsoft Networks.

	<p><b>Note:</b> It is not necessary to remove any other network components shown in the Network window in order to install the adapter, TCP/IP, or Client for Microsoft Networks.</p>
---	---

If you need to install a new adapter, follow these steps:

- a. Click the Add button.
- b. Select Adapter, and then click Add.
- c. Select the manufacturer and model of your Ethernet adapter, and then click OK.

If you need TCP/IP:

- a. Click the Add button.
- b. Select Protocol, and then click Add.
- c. Select Microsoft.
- d. Select TCP/IP, and then click OK.

If you need Client for Microsoft Networks:

- a. Click the Add button.
  - b. Select Client, and then click Add.
  - c. Select Microsoft.
  - d. Select Client for Microsoft Networks, and then click OK.
3. Restart your PC for the changes to take effect.

## Enabling DHCP to Automatically Configure TCP/IP Settings

After the TCP/IP protocol components are installed, each PC must be assigned specific information about itself and resources that are available on its network. The simplest way to configure this information is to allow the PC to obtain the information from a DHCP server in the network.

You will find there are many similarities in the procedures for different Windows systems when using DHCP to configure TCP/IP.

The following steps will walk you through the configuration process for each of these versions of Windows.

**1**

Locate your **Network Neighborhood** icon.

- If the Network Neighborhood icon is on the Windows desktop, position your mouse pointer over it and right-click your mouse button.
- If the icon is not on the desktop,
  - Click **Start** on the task bar located at the bottom left of the window.
  - Choose **Settings**, and then **Control Panel**.
  - Locate the **Network Neighborhood** icon and click on it. This will open the Network panel as shown below.



**2**

Verify the following settings as shown:

- Client for Microsoft Network exists
- Ethernet adapter is present
- TCP/IP is present
- **Primary Network Logon** is set to Windows logon

Click on the **Properties** button. The following TCP/IP Properties window will display.

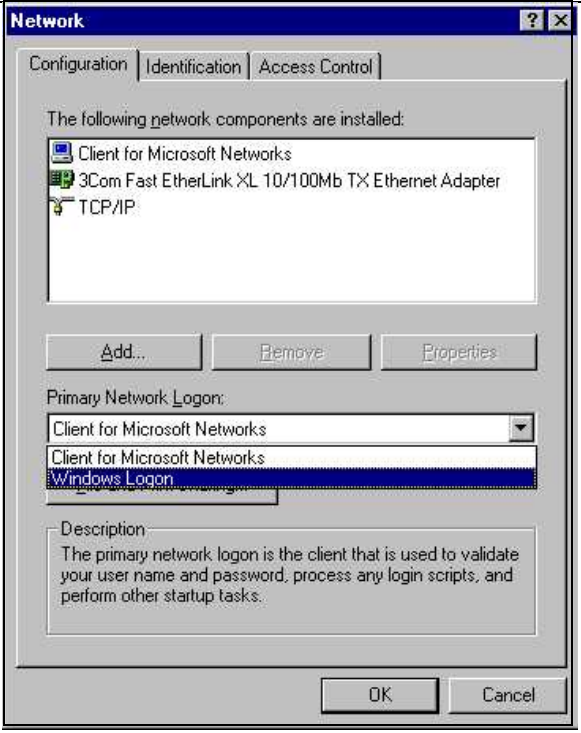

**3**

- By default, the **IP Address** tab is open on this window.
- Verify the following:
  - Obtain an IP address automatically** is selected. If not selected, click in the radio button to the left of it to select it. This setting is required to enable the DHCP server to automatically assign an IP address.
  - Click **OK** to continue.

Restart the PC.

Repeat these steps for each PC with this version of Windows on your network.

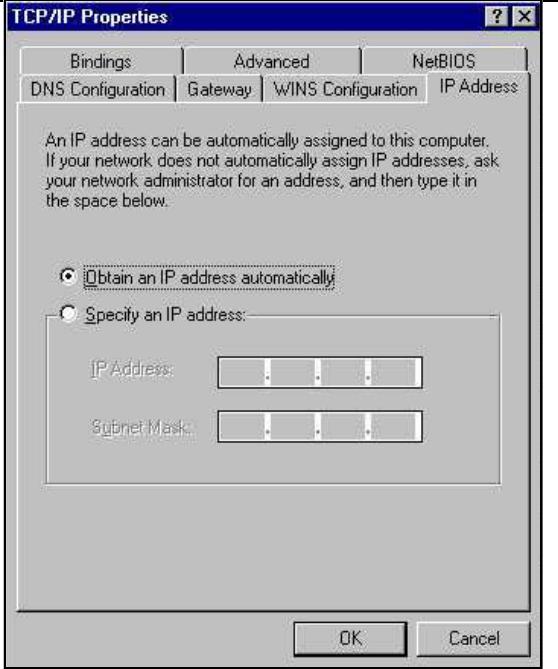

## Selecting Windows' Internet Access Method

1. On the Windows taskbar, click the Start button, point to Settings, and then click Control Panel.
2. Double-click the Internet Options icon.
3. Select “I want to set up my Internet connection manually” or “I want to connect through a Local Area Network” and click Next.
4. Select “I want to connect through a Local Area Network” and click Next.
5. Uncheck all boxes in the LAN Internet Configuration screen and click Next.
6. Proceed to the end of the Wizard.

## Verifying TCP/IP Properties

After your PC is configured and has rebooted, you can check the TCP/IP configuration using the utility *winipcfg.exe*:

1. On the Windows taskbar, click the Start button, and then click Run.

2. Type `winipcfg`, and then click OK.

The IP Configuration window opens, which lists (among other things), your IP address, subnet mask, and default gateway.

3. From the drop-down box, select your Ethernet adapter.

The window is updated to show your settings, which should match the values below if you are using the default TCP/IP settings that NETGEAR recommends for connecting through a router or gateway:

- The IP address is between 192.168.0.2 and 192.168.0.254
- The subnet mask is 255.255.255.0
- The default gateway is 192.168.0.1

## **Configuring Windows NT4, 2000 or XP for IP Networking**

---

As part of the PC preparation process, you may need to install and configure TCP/IP on each networked PC. Before starting, locate your Windows CD; you may need to insert it during the TCP/IP installation process.

### **Install or Verify Windows Networking Components**

To install or verify the necessary components for IP networking:

1. On the Windows taskbar, click the Start button, point to Settings, and then click Control Panel.
2. Double-click the Network and Dialup Connections icon.
3. If an Ethernet adapter is present in your PC, you should see an entry for Local Area Connection. Double-click that entry.
4. Select Properties.
5. Verify that 'Client for Microsoft Networks' and 'Internet Protocol (TCP/IP)' are present. If not, select Install and add them.
6. Select 'Internet Protocol (TCP/IP)', click Properties, and verify that "Obtain an IP address automatically is selected.
7. Click OK and close all Network and Dialup Connections windows.
8. Then, restart your PC.

## DHCP Configuration of TCP/IP in Windows XP, 2000, or NT4

You will find there are many similarities in the procedures for different Windows systems when using DHCP to configure TCP/IP.

The following steps will walk you through the configuration process for each of these versions of Windows.

### DHCP Configuration of TCP/IP in Windows XP

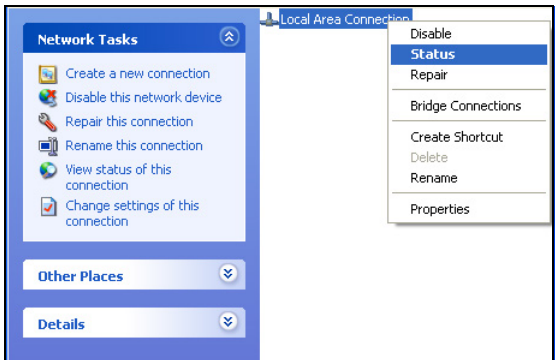
<p><b>1</b></p> <p>Locate your <b>Network Neighborhood</b> icon.</p> <ul style="list-style-type: none"><li>• Select <b>Control Panel</b> from the Windows XP new Start Menu.</li><li>• Select the <b>Network Connections</b> icon on the Control Panel. This will take you to the next step.</li></ul>	
<p><b>2</b></p> <ul style="list-style-type: none"><li>• Now the Network Connection window displays. The Connections List that shows all the network connections set up on the PC, located to the right of the window.</li><li>• Right-click on the <b>Connection</b> you will use and choose <b>Status</b>.</li></ul>	

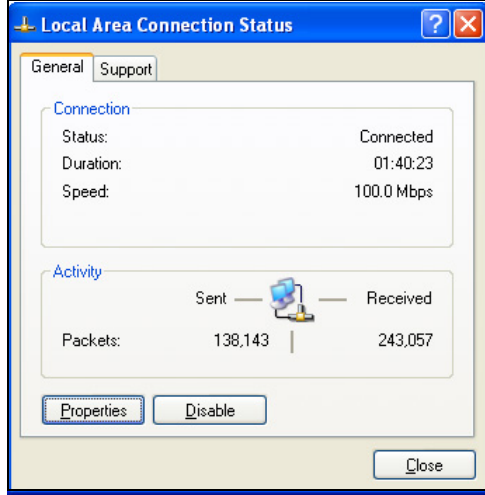
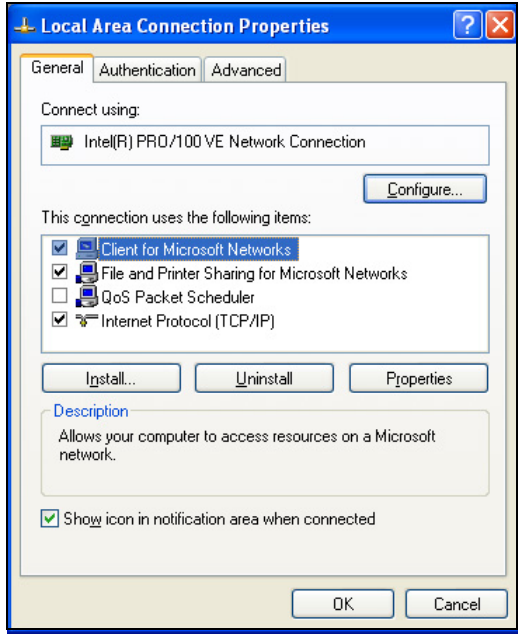
<p><b>3</b></p> <ul style="list-style-type: none"> <li>• Now you should be at the Local Area Network Connection Status window. This box displays the connection status, duration, speed, and activity statistics.</li> <li>• Administrator logon access rights are needed to use this window.</li> <li>• Click the <b>Properties</b> button to view details about the connection.</li> </ul>	
<p><b>4</b></p> <ul style="list-style-type: none"> <li>• The TCP/IP details are presented on the Support tab page.</li> <li>• Select <b>Internet Protocol</b>, and click <b>Properties</b> to view the configuration information.</li> </ul>	

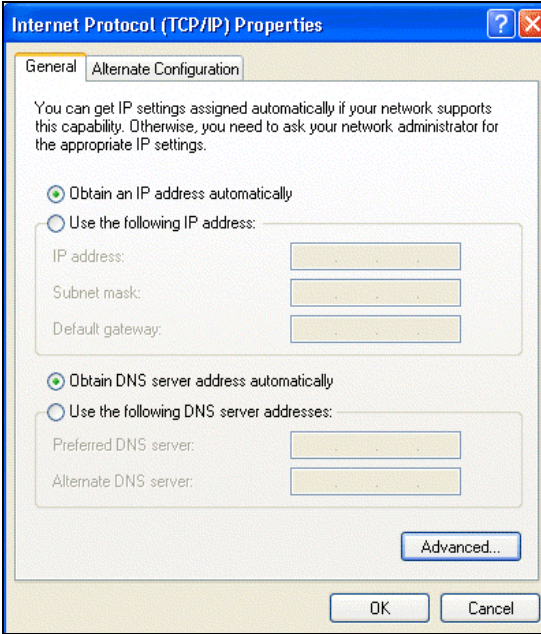
<p><b>5</b></p> <ul style="list-style-type: none"><li>• Verify that the <b>Obtain an IP address automatically</b> radio button is selected.</li><li>• Verify that <b>Obtain DNS server address automatically</b> radio button is selected.</li><li>• Click the <b>OK</b> button.</li></ul> <p>This completes the DHCP configuration of TCP/IP in Windows XP.</p> <p>Repeat these steps for each PC with this version of Windows on your network.</p>	 <p>The screenshot shows the 'Internet Protocol (TCP/IP) Properties' dialog box. The 'General' tab is active. The text at the top reads: 'You can get IP settings assigned automatically if your network supports this capability. Otherwise, you need to ask your network administrator for the appropriate IP settings.' There are two radio button options: 'Obtain an IP address automatically' (which is selected) and 'Use the following IP address:'. Below the second option are three text boxes for 'IP address:', 'Subnet mask:', and 'Default gateway:'. There are also two radio button options for DNS: 'Obtain DNS server address automatically' (selected) and 'Use the following DNS server addresses:'. Below the second option are two text boxes for 'Preferred DNS server:' and 'Alternate DNS server:'. At the bottom right of the dialog box are buttons for 'Advanced...', 'OK', and 'Cancel'.</p>
--	---

## DHCP Configuration of TCP/IP in Windows 2000

Once again, after you have installed the network card, TCP/IP for Windows 2000 is configured. TCP/IP should be added by default and set to DHCP without your having to configure it. However, if there are problems, follow these steps to configure TCP/IP with DHCP for Windows 2000.

1

- Click on the **My Network Places** icon on the Windows desktop. This will bring up a window called Network and Dial-up Connections.
- Right click on **Local Area Connection** and select **Properties**.

2

- The **Local Area Connection Properties** dialog box appears.
- Verify that you have the correct Ethernet card selected in the **Connect using:** box.
- Verify that at least the following two items are displayed and selected in the box of “Components checked are used by this connection:”
  - Client for Microsoft Networks and
  - Internet Protocol (TCP/IP)
- Click **OK**.

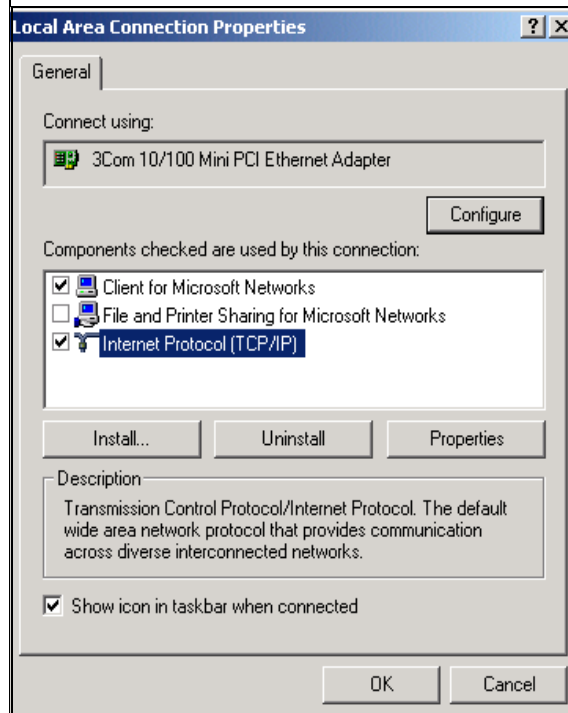

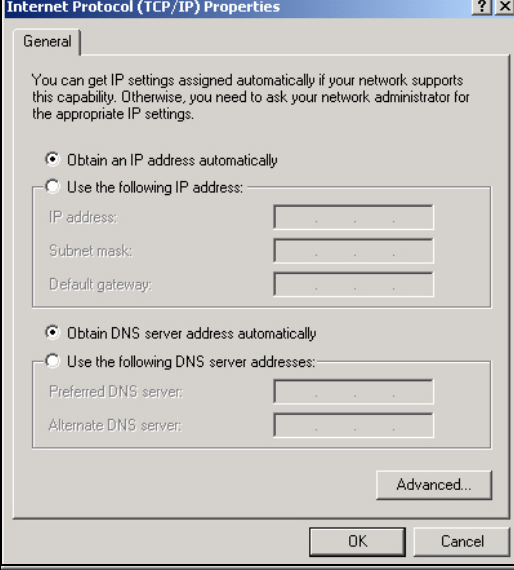
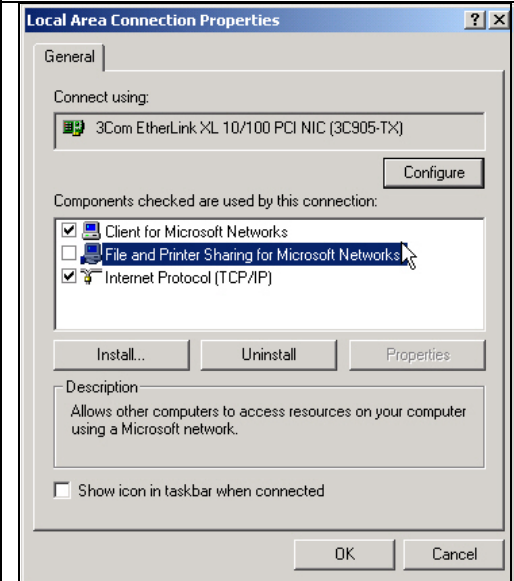
<p><b>3</b></p> <ul style="list-style-type: none"> <li>• With Internet Protocol (TCP/IP) selected, click on <b>Properties</b> to open the Internet Protocol (TCP/IP) Properties dialogue box.</li> <li>• Verify that             <ul style="list-style-type: none"> <li>• <b>Obtain an IP address automatically</b> is selected.</li> <li>• <b>Obtain DNS server address automatically</b> is selected.</li> </ul> </li> <li>• Click <b>OK</b> to return to Local Area Connection Properties.</li> </ul>	
<p><b>4</b></p> <ul style="list-style-type: none"> <li>• Click <b>OK</b> again to complete the configuration process for Windows 2000.</li> </ul> <p>Restart the PC.</p> <p>Repeat these steps for each PC with this version of Windows on your network.</p>	



## DHCP Configuration of TCP/IP in Windows NT4

Once you have installed the network card, you need to configure the TCP/IP environment for Windows NT 4.0. Follow this procedure to configure TCP/IP with DHCP in Windows NT 4.0.

1

- Choose **Settings** from the Start Menu, and then select **Control Panel**. This will display Control Panel window.

2

- Double-click the **Network** icon in the Control Panel window.  
The Network panel will display.
- Select the **Protocols** tab to continue.

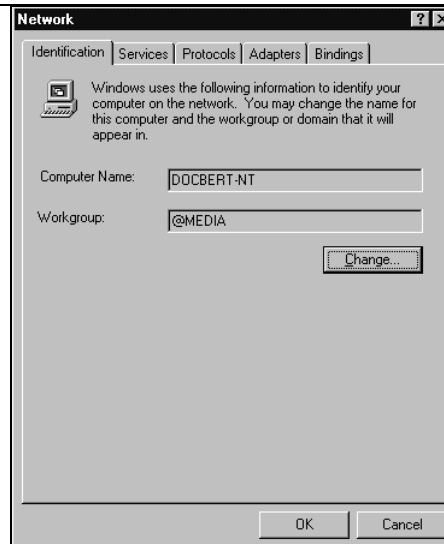

**3**

- Highlight the **TCP/IP Protocol** in the **Network Protocols** box, and click on the **Properties** button.

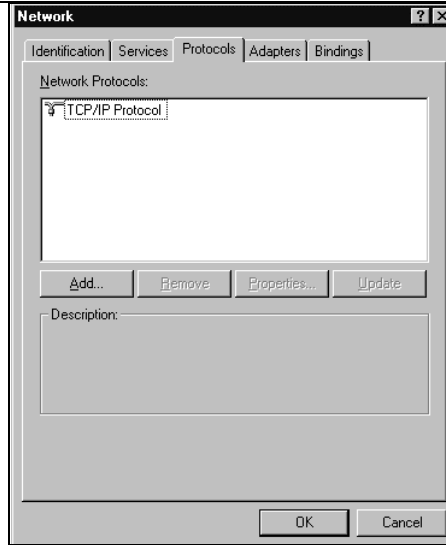

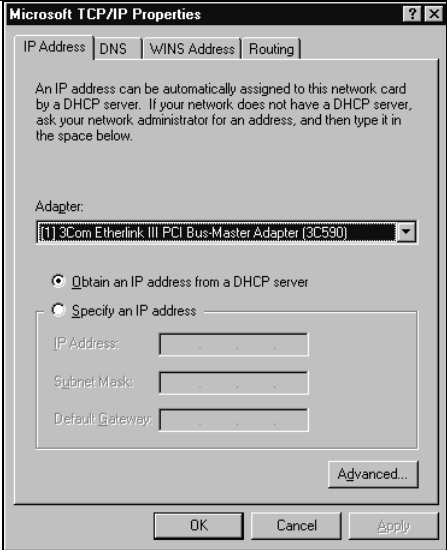
<p><b>4</b></p> <ul style="list-style-type: none"><li>• The <b>TCP/IP Properties</b> dialog box now displays.</li><li>• Click the <b>IP Address</b> tab.</li><li>• Select the radio button marked <b>Obtain an IP address from a DHCP server</b>.</li><li>• Click <b>OK</b>. This completes the configuration of TCP/IP in Windows NT.</li></ul> <p>Restart the PC.</p> <p>Repeat these steps for each PC with this version of Windows on your network.</p>	
---	--

## Verifying TCP/IP Properties for Windows XP, 2000, and NT4

To check your PC's TCP/IP configuration:

1. On the Windows taskbar, click the Start button, and then click Run.

The Run window opens.

2. Type `cmd` and then click OK.

A command window opens

3. Type `ipconfig /all`

Your IP Configuration information will be listed, and should match the values below if you are using the default TCP/IP settings that NETGEAR recommends for connecting through a router or gateway:

- The IP address is between 192.168.0.2 and 192.168.0.254
- The subnet mask is 255.255.255.0

- The default gateway is 192.168.0.1

4. Type `exit`

## Configuring the Macintosh for TCP/IP Networking

---

Beginning with Macintosh Operating System 7, TCP/IP is already installed on the Macintosh. On each networked Macintosh, you will need to configure TCP/IP to use DHCP.

### MacOS 8.6 or 9.x

1. From the Apple menu, select Control Panels, then TCP/IP.

The TCP/IP Control Panel opens:

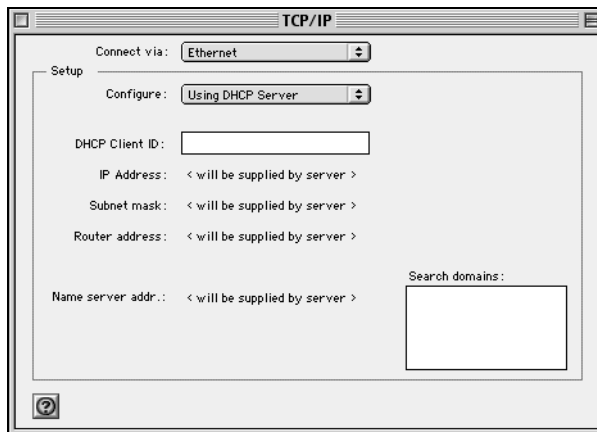

2. From the “Connect via” box, select your Macintosh’s Ethernet interface.

3. From the “Configure” box, select Using DHCP Server.

You can leave the DHCP Client ID box empty.

4. Close the TCP/IP Control Panel.

5. Repeat this for each Macintosh on your network.

### MacOS X

1. From the Apple menu, choose System Preferences, then Network.

2. If not already selected, select Built-in Ethernet in the Configure list.
3. If not already selected, Select Using DHCP in the TCP/IP tab.
4. Click Save.

## Verifying TCP/IP Properties for Macintosh Computers

After your Macintosh is configured and has rebooted, you can check the TCP/IP configuration by returning to the TCP/IP Control Panel. From the Apple menu, select Control Panels, then TCP/IP.

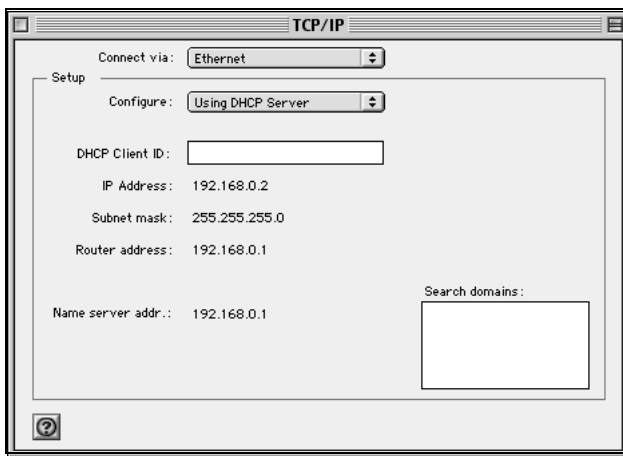

The panel is updated to show your settings, which should match the values below if you are using the default TCP/IP settings that NETGEAR recommends:

- The IP Address is between 192.168.0.2 and 192.168.0.254
- The Subnet mask is 255.255.255.0
- The Router address is 192.168.0.1

If you do not see these values, you may need to restart your Macintosh or you may need to switch the “Configure” setting to a different option, then back again to “Using DHCP Server”.

## Verifying the Readiness of Your Internet Account

---

For broadband access to the Internet, you need to contract with an Internet service provider (ISP) for a single-user Internet access account using a cable modem or DSL modem. This modem must be a separate physical box (not a card) and must provide an Ethernet port intended for connection to a Network Interface Card (NIC) in a computer. Your firewall does not support a USB-connected broadband modem.

For a single-user Internet account, your ISP supplies TCP/IP configuration information for one computer. With a typical account, much of the configuration information is dynamically assigned when your PC is first booted up while connected to the ISP, and you will not need to know that dynamic information.

In order to share the Internet connection among several computers, your firewall takes the place of the single PC, and you need to configure it with the TCP/IP information that the single PC would normally use. When the firewall's Internet port is connected to the broadband modem, the firewall appears to be a single PC to the ISP. The firewall then allows the PCs on the local network to masquerade as the single PC to access the Internet through the broadband modem. The method used by the firewall to accomplish this is called Network Address Translation (NAT) or IP masquerading.

### Are Login Protocols Used?

Some ISPs require a special login protocol, in which you must enter a login name and password in order to access the Internet. If you normally log in to your Internet account by running a program such as WinPOET or EnterNet, then your account uses PPP over Ethernet (PPPoE).

When you configure your router, you will need to enter your login name and password in the router's configuration menus. After your network and firewall are configured, the firewall will perform the login task when needed, and you will no longer need to run the login program from your PC. It is not necessary to uninstall the login program.

### What Is Your Configuration Information?

More and more, ISPs are dynamically assigning configuration information. However, if your ISP does not dynamically assign configuration information but instead used fixed configurations, your ISP should have given you the following basic information for your account:

- An IP address and subnet mask
- A gateway IP address, which is the address of the ISP's router
- One or more domain name server (DNS) IP addresses
- Host name and domain suffix

For example, your account's full server names may look like this:

`mail.xxx.yyy.com`

In this example, the domain suffix is `xxx.yyy.com`.

If any of these items are dynamically supplied by the ISP, your firewall automatically acquires them.

If an ISP technician configured your PC during the installation of the broadband modem, or if you configured it using instructions provided by your ISP, you need to copy the configuration information from your PC's Network TCP/IP Properties window or Macintosh TCP/IP Control Panel before reconfiguring your PC for use with the firewall. These procedures are described next.

## Obtaining ISP Configuration Information for Windows Computers

As mentioned above, you may need to collect configuration information from your PC so that you can use this information when you configure the WGR614 router. Following this procedure is only necessary when your ISP does not dynamically supply the account information.

To get the information you need to configure the firewall for Internet access:

1. On the Windows taskbar, click the Start button, point to Settings, and then click Control Panel.
2. Double-click the Network icon.

The Network window opens, which displays a list of installed components.

3. Select TCP/IP, and then click Properties.

The TCP/IP Properties dialog box opens.

4. Select the IP Address tab.

If an IP address and subnet mask are shown, write down the information. If an address is present, your account uses a fixed (static) IP address. If no address is present, your account uses a dynamically-assigned IP address. Click "Obtain an IP address automatically".

5. Select the Gateway tab.

If an IP address appears under Installed Gateways, write down the address. This is the ISP's gateway address. Select the address and then click Remove to remove the gateway address.

6. Select the DNS Configuration tab.

If any DNS server addresses are shown, write down the addresses. If any information appears in the Host or Domain information box, write it down. Click Disable DNS.

7. Click OK to save your changes and close the TCP/IP Properties dialog box.

You are returned to the Network window.

8. Click OK.
9. Reboot your PC at the prompt. You may also be prompted to insert your Windows CD.

## **Obtaining ISP Configuration Information for Macintosh Computers**

As mentioned above, you may need to collect configuration information from your Macintosh so that you can use this information when you configure the WGR614 router. Following this procedure is only necessary when your ISP does not dynamically supply the account information.

To get the information you need to configure the firewall for Internet access:

1. From the Apple menu, select Control Panels, then TCP/IP.

The TCP/IP Control Panel opens, which displays a list of configuration settings. If the "Configure" setting is "Using DHCP Server", your account uses a dynamically-assigned IP address. In this case, close the Control Panel and skip the rest of this section.

2. If an IP address and subnet mask are shown, write down the information.
3. If an IP address appears under Router address, write down the address. This is the ISP's gateway address.
4. If any Name Server addresses are shown, write down the addresses. These are your ISP's DNS addresses.
5. If any information appears in the Search domains information box, write it down.
6. Change the "Configure" setting to "Using DHCP Server".
7. Close the TCP/IP Control Panel.



## **Restarting the Network**

---

Once you've set up your computers to work with the firewall, you must reset the network for the devices to be able to communicate correctly. Restart any computer that is connected to the firewall.

After configuring all of your computers for TCP/IP networking and restarting them, and connecting them to the local network of your WGR614 router, you are ready to access and configure the firewall.

This page intentionally left blank.

# Appendix D

## Wireless Networking Basics

This chapter provides an overview of Wireless networking.

### Wireless Networking Overview

---

The WGR614 router conforms to the Institute of Electrical and Electronics Engineers (IEEE) 802.11 standard for wireless LANs (WLANs) and a product update will bring the WGR614 into conformance to the 802.11g standard when it is ratified. On an 802.11b or g wireless link, data is encoded using direct-sequence spread-spectrum (DSSS) technology and is transmitted in the unlicensed radio spectrum at 2.5GHz. The maximum data rate for the wireless link is 11 Mbps, but it will automatically back down from 11 Mbps to 5.5, 2, and 1 Mbps when the radio signal is weak or when interference is detected. The 802.11g auto rate sensing rates are 1, 2, 5.5, 6, 9, 12, 18, 24, 36, 48, and 54 Mbps.

The 802.11 standard is also called Wireless Ethernet or Wi-Fi by the Wireless Ethernet Compatibility Alliance (WECA, see <http://www.wi-fi.net>), an industry standard group promoting interoperability among 802.11 devices. The 802.11 standard offers two methods for configuring a wireless network - ad hoc and infrastructure.

## Infrastructure Mode

With a wireless Access Point, you can operate the wireless LAN in the infrastructure mode. This mode provides wireless connectivity to multiple wireless network devices within a fixed range or area of coverage, interacting with wireless nodes via an antenna.

In the infrastructure mode, the wireless access point converts airwave data into wired Ethernet data, acting as a bridge between the wired LAN and wireless clients. Connecting multiple Access Points via a wired Ethernet backbone can further extend the wireless network coverage. As a mobile computing device moves out of the range of one access point, it moves into the range of another. As a result, wireless clients can freely roam from one Access Point domain to another and still maintain seamless network connection.

## Ad Hoc Mode (Peer-to-Peer Workgroup)

In an ad hoc network, computers are brought together as needed; thus, there is no structure or fixed points to the network - each node can generally communicate with any other node. There is no Access Point involved in this configuration. This mode enables you to quickly set up a small wireless workgroup and allows workgroup members to exchange data or share printers as supported by Microsoft networking in the various Windows operating systems. Some vendors also refer to ad hoc networking as peer-to-peer group networking.

In this configuration, network packets are directly sent and received by the intended transmitting and receiving stations. As long as the stations are within range of one another, this is the easiest and least expensive way to set up a wireless network.

## Network Name: Extended Service Set Identification (ESSID)

The Extended Service Set Identification (ESSID) is one of two types of Service Set Identification (SSID). In an ad hoc wireless network with no access points, the Basic Service Set Identification (BSSID) is used. In an infrastructure wireless network that includes an access point, the ESSID is used, but may still be referred to as SSID.

An SSID is a thirty-two character (maximum) alphanumeric key identifying the name of the wireless local area network. Some vendors refer to the SSID as network name. For the wireless devices in a network to communicate with each other, all devices must be configured with the same SSID.

## Authentication and WEP

---

The absence of a physical connection between nodes makes the wireless links vulnerable to eavesdropping and information theft. To provide a certain level of security, the IEEE 802.11 standard has defined two types of authentication methods, Open System and Shared Key. With Open System authentication, a wireless PC can join any network and receive any messages that are not encrypted. With Shared Key authentication, only those PCs that possess the correct authentication key can join the network. By default, IEEE 802.11 wireless devices operate in an Open System network.

Wired Equivalent Privacy (WEP) data encryption is used when the wireless devices are configured to operate in Shared Key authentication mode. There are two shared key methods implemented in most commercially available products, 64-bit and 128-bit WEP data encryption.

### 802.11 Authentication

The 802.11 standard defines several services that govern how two 802.11 devices communicate. The following events must occur before an 802.11 Station can communicate with an Ethernet network through an access point such as the one built in to the WGR614:

1. Turn on the wireless station.
2. The station listens for messages from any access points that are in range.
3. The station finds a message from an access point that has a matching SSID.
4. The station sends an authentication request to the access point.
5. The access point authenticates the station.
6. The station sends an association request to the access point.
7. The access point associates with the station.
8. The station can now communicate with the Ethernet network through the access point.

An access point must authenticate a station before the station can associate with the access point or communicate with the network. The IEEE 802.11 standard defines two types of authentication: Open System and Shared Key.

- Open System Authentication allows any device to join the network, assuming that the device SSID matches the access point SSID. Alternatively, the device can use the “ANY” SSID option to associate with any available Access Point within range, regardless of its SSID.

- Shared Key Authentication requires that the station and the access point have the same WEP Key to authenticate. These two authentication procedures are described below.

## Open System Authentication

The following steps occur when two devices use Open System Authentication:

1. The station sends an authentication request to the access point.
2. The access point authenticates the station.
3. The station associates with the access point and joins the network.

This process is illustrated in below.

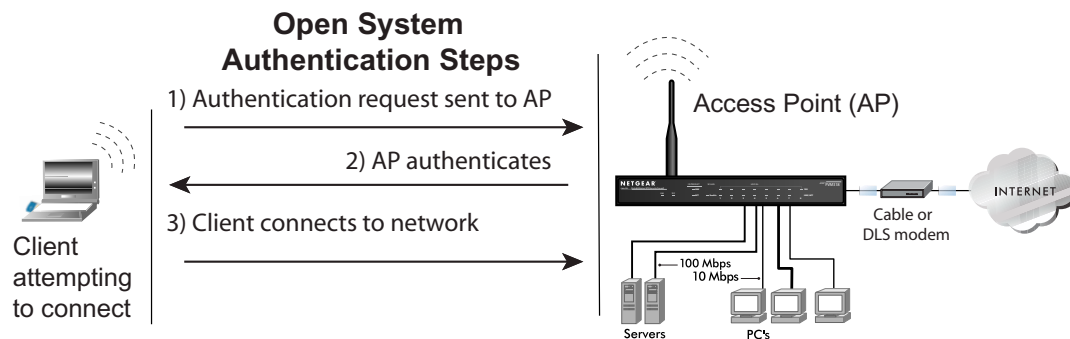

Figure 10-1: Open system authentication

## Shared Key Authentication

The following steps occur when two devices use Shared Key Authentication:

1. The station sends an authentication request to the access point.
2. The access point sends challenge text to the station.
3. The station uses its configured 64-bit or 128-bit default key to encrypt the challenge text, and sends the encrypted text to the access point.
4. The access point decrypts the encrypted text using its configured WEP Key that corresponds to the station's default key. The access point compares the decrypted text with the original challenge text. If the decrypted text matches the original challenge text, then the access point and the station share the same WEP Key and the access point authenticates the station.

5. The station connects to the network.

If the decrypted text does not match the original challenge text (i.e., the access point and station do not share the same WEP Key), then the access point will refuse to authenticate the station and the station will be unable to communicate with either the 802.11 network or Ethernet network.

This process is illustrated in below.

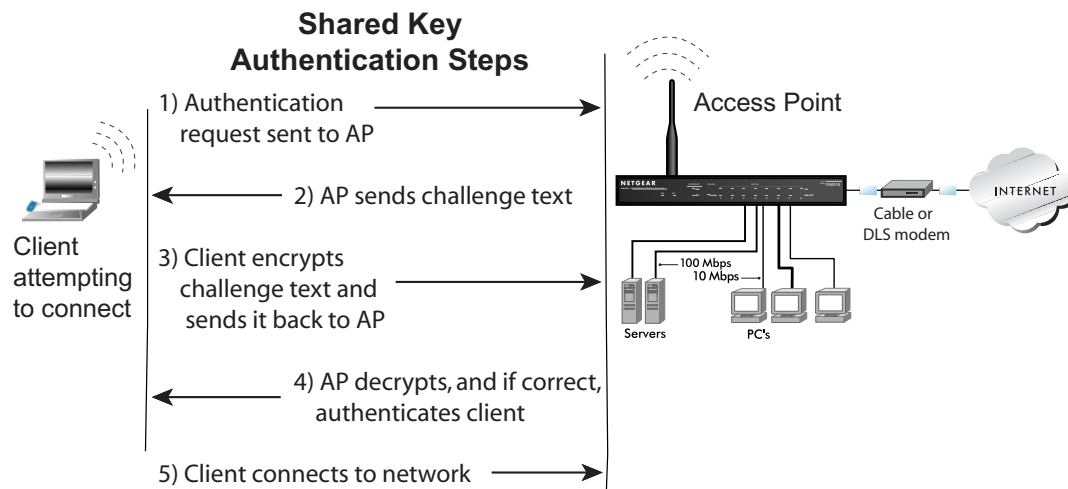

Figure 10-2: Shared key authentication

## Overview of WEP Parameters

Before enabling WEP on an 802.11 network, you must first consider what type of encryption you require and the key size you want to use. Typically, there are three WEP Encryption options available for 802.11 products:

1. **Do Not Use WEP:** The 802.11 network does not encrypt data. For authentication purposes, the network uses Open System Authentication.
2. **Use WEP for Encryption:** A transmitting 802.11 device encrypts the data portion of every packet it sends using a configured WEP Key. The receiving device decrypts the data using the same WEP Key. For authentication purposes, the wireless network uses Open System Authentication.

**3. Use WEP for Authentication and Encryption:** A transmitting 802.11 device encrypts the data portion of every packet it sends using a configured WEP Key. The receiving 802.11 device decrypts the data using the same WEP Key. For authentication purposes, the 802.11 network uses Shared Key Authentication.

**Note:** Some 802.11 access points also support **Use WEP for Authentication Only** (Shared Key Authentication without data encryption).

## Key Size

The IEEE 802.11 standard supports two types of WEP encryption: 40-bit and 128-bit.

The 64-bit WEP data encryption method, allows for a five-character (40-bit) input. Additionally, 24 factory-set bits are added to the forty-bit input to generate a 64-bit encryption key. (The 24 factory-set bits are not user-configurable). This encryption key will be used to encrypt/decrypt all data transmitted via the wireless interface. Some vendors refer to the 64-bit WEP data encryption as 40-bit WEP data encryption since the user-configurable portion of the encryption key is 40 bits wide.

The 128-bit WEP data encryption method consists of 104 user-configurable bits. Similar to the forty-bit WEP data encryption method, the remaining 24 bits are factory set and not user configurable. Some vendors allow passphrases to be entered instead of the cryptic hexadecimal characters to ease encryption key entry.

128-bit encryption is stronger than 40-bit encryption, but 128-bit encryption may not be available outside of the United States due to U.S. export regulations.

When configured for 40-bit encryption, 802.11 products typically support up to four WEP Keys. Each 40-bit WEP Key is expressed as 5 sets of two hexadecimal digits (0-9 and A-F). For example, “12 34 56 78 90” is a 40-bit WEP Key.

When configured for 128-bit encryption, wireless products typically support four WEP Keys but some manufacturers support only one 128-bit key. The 128-bit WEP Key is expressed as 13 sets of two hexadecimal digits (0-9 and A-F). For example, “12 34 56 78 90 AB CD EF 12 34 56 78 90” is a 128-bit WEP Key.

**Note:** Typically, 802.11 access points can store up to four 128-bit WEP Keys but some 802.11 client adapters can only store one. Therefore, make sure that your 802.11 access and client adapters configurations match.



## WEP Configuration Options

The WEP settings must match on all 802.11 devices that are within the same wireless network as identified by the SSID. In general, if your mobile clients will roam between access points, then all of the 802.11 access points and all of the 802.11 client adapters on the network must have the same WEP settings.

**Note:** Whatever keys you enter for an AP, you must also enter the same keys for the client adapter in the same order. In other words, WEP key 1 on the AP must match WEP key 1 on the client adapter, WEP key 2 on the AP must match WEP key 2 on the client adapter, etc.

**Note:** The AP and the client adapters can have different default WEP Keys as long as the keys are in the same order. In other words, the AP can use WEP key 2 as its default key to transmit while a client adapter can use WEP key 3 as its default key to transmit. The two devices will communicate as long as the AP's WEP key 2 is the same as the client's WEP key 2 and the AP's WEP key 3 is the same as the client's WEP key 3.

## Wireless Channels

---

IEEE 802.11 wireless nodes communicate with each other using radio frequency signals in the ISM (Industrial, Scientific, and Medical) band between 2.4 GHz and 2.5 GHz. Neighboring channels are 5 MHz apart. However, due to spread spectrum effect of the signals, a node sending signals using a particular channel will utilize frequency spectrum 12.5 MHz above and below the center channel frequency. As a result, two separate wireless networks using neighboring channels (for example, channel 1 and channel 2) in the same general vicinity will interfere with each other. Applying two channels that allow the maximum channel separation will decrease the amount of channel crosstalk, and provide a noticeable performance increase over networks with minimal channel separation.

The radio frequency channels used are listed in [Table 11](#):

**Table 11. 802.11 Radio Frequency Channels**

Channel	Center Frequency	Frequency Spread
1	2412 MHz	2399.5 MHz - 2424.5 MHz
2	2417 MHz	2404.5 MHz - 2429.5 MHz
3	2422 MHz	2409.5 MHz - 2434.5 MHz
4	2427 MHz	2414.5 MHz - 2439.5 MHz
5	2432 MHz	2419.5 MHz - 2444.5 MHz
6	2437 MHz	2424.5 MHz - 2449.5 MHz
7	2442 MHz	2429.5 MHz - 2454.5 MHz
8	2447 MHz	2434.5 MHz - 2459.5 MHz
9	2452 MHz	2439.5 MHz - 2464.5 MHz
10	2457 MHz	2444.5 MHz - 2469.5 MHz
11	2462 MHz	2449.5 MHz - 2474.5 MHz
12	2467 MHz	2454.5 MHz - 2479.5 MHz
13	2472 MHz	2459.5 MHz - 2484.5 MHz

**Note:** The available channels supported by the wireless products in various countries are different.

The preferred channel separation between the channels in neighboring wireless networks is 25 MHz (5 channels). This means that you can apply up to three different channels within your wireless network. There are only 11 usable wireless channels in the United States. It is recommended that you start using channel 1 and grow to use channel 6, and 11 when necessary, as these three channels do not overlap.

# Glossary

<b>10BASE-T</b>	IEEE 802.3 specification for 10 Mbps Ethernet over twisted pair wiring.
<b>100BASE-Tx</b>	IEEE 802.3 specification for 100 Mbps Ethernet over twisted pair wiring.
<b>802.11b</b>	IEEE specification for wireless networking at 11 Mbps using direct-sequence spread-spectrum (DSSS) technology and operating in the unlicensed radio spectrum at 2.5GHz.
<b>802.11g</b>	An as yet to be approved IEEE specification for wireless networking at 54 Mbps using direct-sequence spread-spectrum (DSSS) technology and operating in the unlicensed radio spectrum at 2.5GHz. 802.11g is backwards compatible with the existing 802.11b standard. When the standard is ratified, if necessary, a firmware upgrade may be offered bring your Netgear product into compliance with the standard.
<b>Denial of Service attack</b>	DoS. A hacker attack designed to prevent your computer or network from operating or communicating.
<b>DHCP</b>	<i>See</i> Dynamic Host Configuration Protocol.
<b>DMZ</b>	A Demilitarized Zone is used by a company that wants to host its own Internet services without sacrificing unauthorized access to its private network. The DMZ sits between the Internet and an internal network's line of defense, usually some combination of firewalls and bastion hosts. Typically, the DMZ contains devices accessible to Internet traffic, such as Web (HTTP) servers, FTP servers, SMTP (e-mail) servers and DNS servers.
<b>DNS</b>	<i>See</i> Domain Name Server.
<b>domain name</b>	A descriptive name for an address or group of addresses on the Internet. Domain names are of the form of a registered entity name plus one of a number of predefined top level suffixes such as .com, .edu, .uk, etc. For example, in the address mail.NETGEAR.com, mail is a server name and NETGEAR.com is the domain.

<b>Domain Name Server</b>	A Domain Name Server (DNS) resolves descriptive names of network resources (such as www.NETGEAR.com) to numeric IP addresses.
<b>Dynamic Host Configuration Protocol</b>	DHCP. An Ethernet protocol specifying how a centralized DHCP server can assign network configuration information to multiple DHCP clients. The assigned information includes IP addresses, DNS addresses, and gateway (router) addresses.
<b>Gateway</b>	A local device, usually a router, that connects hosts on a local network to other networks.
<b>IP</b>	<i>See</i> Internet Protocol.
<b>IP Address</b>	A four-byte number uniquely defining each host on the Internet. Ranges of addresses are assigned by Internic, an organization formed for this purpose. Usually written in dotted-decimal notation with periods separating the bytes (for example, 134.177.244.57).
<b>ISP</b>	Internet service provider.
<b>Internet Protocol</b>	The main internetworking protocol used in the Internet. Used in conjunction with the Transfer Control Protocol (TCP) to form TCP/IP.
<b>LAN</b>	<i>See</i> local area network.
<b>local area network</b>	LAN. A communications network serving users within a limited area, such as one floor of a building. A LAN typically connects multiple personal computers and shared network devices such as storage and printers. Although many technologies exist to implement a LAN, Ethernet is the most common for connecting personal computers.
<b>MAC address</b>	Media Access Control address. A unique 48-bit hardware address assigned to every Ethernet node. Usually written in the form 01:23:45:67:89:ab.
<b>Mbps</b>	Megabits per second.
<b>MTU</b>	<i>See</i> Maximum Transmission Unit.
<b>Maximum Transmission Unit</b>	The size in bytes of the largest packet that can be sent or received.
<b>NAT</b>	<i>See</i> Network Address Translation.

<b>netmask</b>	A number that explains which part of an IP address comprises the network address and which part is the host address on that network. It can be expressed in dotted-decimal notation or as a number appended to the IP address. For example, a 28-bit mask starting from the MSB can be shown as 255.255.255.192 or as /28 appended to the IP address.
<b>Network Address Translation</b>	A technique by which several hosts share a single IP address for access to the Internet.
<b>packet</b>	A block of information sent over a network. A packet typically contains a source and destination network address, some protocol and length information, a block of data, and a checksum.
<b>PPP</b>	<i>See</i> Point-to-Point Protocol.
<b>PPP over Ethernet</b>	PPPoE. PPP over Ethernet is a protocol for connecting remote hosts to the Internet over an always-on connection by simulating a dial-up connection.
<b>PPTP</b>	Point-to-Point Tunneling Protocol. A method for establishing a virtual private network (VPN) by embedding Microsoft's network protocol into Internet packets.
<b>Point-to-Point Protocol</b>	PPP. A protocol allowing a computer using TCP/IP to connect directly to the Internet.
<b>RFC</b>	Request For Comment. Refers to documents published by the Internet Engineering Task Force (IETF) proposing standard protocols and procedures for the Internet. RFCs can be found at <a href="http://www.ietf.org">www.ietf.org</a> .
<b>RIP</b>	<i>See</i> Routing Information Protocol.
<b>router</b>	A device that forwards data between networks. An IP router forwards data based on IP source and destination addresses.
<b>Routing Information Protocol</b>	A protocol in which routers periodically exchange information with one another so that they can determine minimum distance paths between sources and destinations.
<b>subnet mask</b>	<i>See</i> netmask.
<b>UPnP</b>	<i>See</i> Universal Plug and Play.

<b>Universal Plug and Play</b>	UPnP. A networking architecture that provides compatibility among networking equipment, software and peripherals of the 400+ vendors that are part of the Universal Plug and Play Forum. UPnP compliant routers provide broadband users at home and small businesses with a seamless way to participate in online games, videoconferencing and other peer-to-peer services.
<b>UTP</b>	Unshielded twisted pair. The cable used by 10BASE-T and 100BASE-Tx Ethernet networks.
<b>WAN</b>	<i>See</i> wide area network.
<b>WEP</b>	Wired Equivalent Privacy. WEP is a data encryption protocol for 802.11 wireless networks. All wireless nodes and access points on the network are configured with a 64-bit or 128-bit Shared Key for data encryption.
<b>wide area network</b>	WAN. A long distance link used to extend or connect remotely located local area networks. The Internet is a large WAN.
<b>Windows Internet Naming Service</b>	WINS. Windows Internet Naming Service is a server process for resolving Windows-based computer names to IP addresses. If a remote network contains a WINS server, your Windows PCs can gather information from that WINS server about its local hosts. This allows your PCs to browse that remote network using Network Neighborhood.
<b>WINS</b>	<i>See</i> Windows Internet Naming Service.

# Index

## Numerics

64 or 128 bit WEP 3-6

802.11b D-1

## A

Account Name 2-11, 2-13, 5-2

Address Resolution Protocol B-9

ad-hoc mode D-2

Authentication Server 2-9

Auto MDI/MDI-X B-13

Auto Uplink 1-3, B-13

## B

backup configuration 5-7

Basic Wireless Connectivity 3-8

BSSID D-2

## C

cables, pinout B-12

Cabling B-12

Cat5 cable 2-1, B-13

configuration

    automatic by DHCP 1-4

    backup 5-7

    erasing 5-8

    restore 5-6

    router, initial 2-1

content filtering 1-2, 4-1

conventions

    typography 1-xi

crossover cable 1-3, 7-2, B-12, B-13

customer support 1-iii

## D

date and time 7-7

Daylight Savings Time 7-7

daylight savings time 4-8

Default DMZ Server 6-5

Denial of Service (DoS) protection 1-2

denial of service attack B-11

DHCP 1-4, B-10

DHCP Client ID C-16

DMZ 1-3, 6-2, 6-5

DMZ Server 6-5

DNS Proxy 1-4

DNS server 2-10, 2-11, 2-13, C-20

DNS, dynamic 6-6

domain C-20

Domain Name 2-11, 2-13

domain name server (DNS) B-10

DoS attack B-11

Dynamic DNS 6-6

## E

Encryption Strength 3-6

End Port 6-2

EnterNet C-18

erase configuration 5-8

ESSID 3-8, D-2

Ethernet 1-3

Ethernet cable B-12

## F

factory settings, restoring 5-8

- firewall features 1-2
- Flash memory, for firmware upgrade 1-2
- front panel 1-6, 1-7
- fully qualified domain name (FQDN) 3-4

## G

- gateway address C-20

## H

- Half Life 6-3
- host name 2-11, 2-13

## I

- IANA
  - contacting B-2
- IETF B-1
  - Web site address B-7
- infrastructure mode D-2
- installation 1-4
- Internet account
  - address information C-18
  - establishing C-18
- Internet Service Provider 2-1
- IP addresses C-19, C-20
  - and NAT B-8
  - and the Internet B-2
  - assigning B-2, B-9
  - auto-generated 7-3
  - private B-7
  - translating B-9
- IP configuration by DHCP B-10
- IP networking
  - for Macintosh C-16
  - for Windows C-2, C-7
- ISP 2-1

## K

- KALI 6-3

## L

- LAN IP Setup Menu 6-7
- LEDs
  - description 1-6
  - troubleshooting 7-2
- log
  - sending 4-7
- log entries 4-6
- Login 2-9

## M

- MAC address 7-7, B-9
  - spoofing 2-10, 2-13, 7-5
- Macintosh C-19
  - configuring for IP networking C-16
  - DHCP Client ID C-16
  - Obtaining ISP Configuration Information C-20
- masquerading C-18
- MDI/MDI-X B-13
- MDI/MDI-X wiring B-12
- metric 6-11

## N

- NAT C-18
- NAT. *See* Network Address Translation
- netmask
  - translation table B-6
- Network Address Translation 1-4, B-8, C-18
- Network Time Protocol 4-8, 7-7
- NTP 4-8, 7-7

## O

- Open System authentication D-3

## P

- package contents 1-5
- Passphrase 3-6, 3-7, 3-11
- passphrase 1-2



- Password 2-9
- password
  - restoring 7-7
- PC, using to configure C-21
- ping 6-5
- pinout, Ethernet cable B-12
- placement 3-1
- port filtering 4-3
- Port Forwarding 6-1
- port forwarding behind NAT B-9
- Port Forwarding Menu 6-1
- port numbers 4-3
- PPP over Ethernet 1-4, C-18
- PPPoE 1-4, C-18
- Primary DNS Server 2-9, 2-11, 2-13
- protocols
  - Address Resolution B-9
  - DHCP 1-4, B-10
  - Routing Information 1-3, B-2
  - support 1-1
- publications, related B-1

**Q**

- Quake 6-3

**R**

- range 3-1
- range, port forwarding 6-2
- rear panel 1-7
- Remote Management 6-12
- remote management 6-12
- requirements
  - hardware 2-1
- reserved IP addresses 6-9
- restore configuration 5-6
- restore factory settings 5-8
- Restrict Wireless Access by MAC Address 3-9
- RFC
  - 1466 B-7, B-9

- 1597 B-7, B-9
- 1631 B-8, B-9
- finding B-7

- RIP (Router Information Protocol) 6-8
- router concepts B-1
- Router Status 5-1
- Routing Information Protocol 1-3, B-2

## **S**

- Secondary DNS Server 2-9, 2-11, 2-13
- security 1-1, 1-3
- service numbers 4-4
- Setup Wizard 2-1
- Shared Key authentication D-3
- SMTP 4-8
- spoof MAC address 7-5
- SSID 3-4, 3-8, 3-9, D-2
- Start Port 6-2
- stateful packet inspection 1-2, B-11
- Static Routes 6-6
- subnet addressing B-5
- subnet mask B-6, C-19, C-20

## **T**

- TCP/IP
  - configuring C-1
  - network, troubleshooting 7-5
- TCP/IP properties
  - verifying for Macintosh C-17
  - verifying for Windows C-6, C-15
- time of day 7-7
- time zone 4-8
- time-stamping 4-8
- troubleshooting 7-1
- Trusted Host 4-3
- typographical conventions 1-xi

## U

Universal Plug and Play 6-13  
Uplink switch B-12  
UPnP 6-13  
USB C-18

## W

WAN 6-4  
WAN Setup 6-4  
WEP D-3  
WEP encryption 1-2  
Wi-Fi D-1  
Windows, configuring for IP routing C-2, C-7  
winipcfg utility C-6  
WinPOET C-18  
Wired Equivalent Privacy. *See* WEP  
Wireless Access 2-3  
Wireless Authentication 3-5  
wireless authentication scheme 3-5  
Wireless Encryption 3-5  
Wireless Ethernet D-1  
Wireless Network Settings 3-4  
Wireless Performance 3-1  
Wireless Range Guidelines 3-1  
Wireless Security 3-2  
World Wide Web 1-iii

## FCC Caution

1. The device complies with Part 15 of the FCC rules. Operation is subject to the following two conditions:
  - (1) This device may not cause harmful interference.
  - (2) This device must accept any interference received, including interference that may cause undesired operation.
2. FCC RF Radiation Exposure Statement: The equipment complies with FCC RF radiation exposure limits set forth for an uncontrolled environment. This equipment should be installed and operated with a minimum distance of 20 centimeters between the radiator and your body.
3. This Transmitter must not be co-located or operating in conjunction with any other antenna or transmitter.
4. Changes or modifications to this unit not expressly approved by the party responsible for compliance could void the user authority to operate the equipment.